

MESA/BOOGIE®

MARK • FIVE™

Owner's Manual



Hello from the Tone Farm

Congratulations on your choice of the MARK V and welcome to the Mesa/Boogie Family! The instrument you've selected has a deep heritage that combines the best attributes of vintage tube amplification with pioneering innovation that brings high-gain channel switching performance to a new frontier. One look to the right side of the Rear Panel - where a stack of 9 patents proclaim the authenticity of these groundbreaking circuits and features (beware imitators) and you should feel a sense of pride that you're playing an amp like no other.

Our 40 year commitment to excellence along with our solemn promise to musicians - to treat each of them as we ourselves would wish to be treated - guarantees you an experience that will make you feel truly justified in your choice. We're confident your new amplifier will have you smiling and inspired within minutes of plugging in for the first time...but what's really gratifying is that you will be finding new and inspiring sounds years after your price of admission has faded from memory and the MARK V continues to unveil it's true worth.

It's with our sincere thanks for trusting us with your TONE and our best wishes for all your musical endeavors that we welcome you home. Should you ever need assistance or guidance we're here to help. You now have in your hands an instrument of limitless expression. Our hope is that it takes you and your playing to new and unimagined places throughout your musical journey. From all of us here at MESA...Enjoy!



Table of Contents

PRECAUTIONS

OVERVIEW: FRONT PANEL	1-4
OVERVIEW: REAR PANEL	5-6
GETTING STARTED	7-10

THE CHANNELS:

CHANNEL 1	11
CHANNEL 2	12
CHANNEL 3	13
NOTE FROM THE AUTHOR	14-16

THE MODES:

CHANNEL 1: OVERVIEW	17
CHANNEL 1 : NORMAL / BOLD	17
CHANNEL 1: CLEAN	18
CHANNEL 1: FAT	18-19
CHANNEL 1: TWEED	19-20

CHANNEL 2: OVERVIEW	20
CHANNEL 2 : MARK I NORMAL / THICK	20
CHANNEL 2: EDGE	21
CHANNEL 2: CRUNCH	21
CHANNEL 2: MARK I	22

CHANNEL 3: OVERVIEW	23
CHANNEL 3: NORMAL / BRIGHT	23
CHANNEL 3: MARK IIC+	24
CHANNEL 3: MARK IIC+	24-25
CHANNEL 3: MARK IV	26-27
CHANNEL 3: EXTREME	28

FRONT PANEL: EQ, POWER SELECT

EQUALIZER	29-30
POWER SELECT: 90W SIMUL CLASS	30
POWER SELECT: 45W EXTENDED CLASS A	31
POWER SELECT: 10W CLASS A	31-32

FRONT PANEL: THE CONTROLS

GAIN	33
MASTER	34
PRESENCE	34-35
TREBLE	35-36
MID	36
BASS	37

FRONT PANEL: FEATURES

OUTPUT & SOLO	38
SOLO: PULL MUTE	38
LED INDICATION	39
STANDBY	39
FULL POWER / VARIAC POWER	39

REAR PANEL: FEATURES

FUSE	40
EXTERNAL SWITCHING	40
EFX LOOP	40-41
REVERB	41
SWITCHABLE RECTIFIERS	42
CHANNEL 3: TRIODE / PENTODE	42
SPEAKERS	43
TUNER OUT	43
SLAVE	43
BIAS SELECT	43

SAMPLE SETTINGS	44-45
USER SETTINGS	46-47
BIAS ADJUSTMENT ARTICLE	48-50
DIAGNOSING TUBE PROBLEMS	51-52
SPEAKER IMPEDANCE HOOKUP GUIDE	53-58
PENTODES, TRIODES AND IRISHMEN	59-61
TUBE TASK CHART	62
PARTS SHEET	63

IMPORTANT SAFETY INSTRUCTIONS

Read these instructions.

Keep these instructions.

Heed all warnings.

Follow all instructions.

Do not use this apparatus near water.

Clean only with dry cloth.

Do not block any ventilation openings. Install in accordance with the manufacturer's instructions.

Do not install near any heat sources such as radiators, heat registers, stoves, or other apparatus (including amplifiers) that produce heat.

Do not defeat the safety purpose of the polarized or grounding-type plug. A polarized plug has two blades with one wider than the other. A grounding type plug has two blades and a third grounding prong. The wide blade or the third prong are provided for your safety. If the provided plug does not fit into your outlet, consult an electrician for replacement of the obsolete outlet.

Protect the power cord from being walked on or pinched particularly at plugs, convenience receptacles, and the point where they exit from the apparatus.

Only use attachments/accessories specified by the manufacturer.

Unplug this apparatus during lightning storms or when unused for long periods of time.

Refer all servicing to qualified service personnel. Servicing is required when the apparatus has been damaged in any way, such as power-supply cord or plug is damaged, liquid has been spilled or objects have fallen into the apparatus, the apparatus has been exposed to rain or moisture, does not operate normally, or has been dropped.

To insure proper ventilation always make sure there is at minimum four inches (101.6mm) of space behind the rear of the apparatus. The ventilation should not be impeded by covering the ventilation openings with items, such as newspapers, tablecloths, curtains, etc. Do not impede ventilation by placing objects on top of the apparatus which extend past the rear edge of its cabinet.

No naked flame sources, such as lighted candles, should be placed on the apparatus.

The apparatus shall not be exposed to dripping or splashing and no objects filled with liquids, such as vases, shall be placed on the apparatus.

WARNING: To reduce the risk of fire or electric shock, do not expose this apparatus to rain or moisture.

The AC plug is the mains disconnect. The plug should remain accessible after installation.

WARNING: EU: permission from the Supply Authority is needed before connection.

WARNING: Always make sure proper load is connected before operating the amplifier. Failure to do so could pose a shock hazard and may result in damage to the amplifier.

Do not expose amplifier to direct sunlight or extremely high temperatures.

Always insure the amplifier is properly grounded. Always unplug AC power cord before changing fuse, tubes or removing chassis. Use only same type and rating when replacing fuse.

Avoid direct contact with heated tubes. Keep amplifier away from children.

To avoid damaging your speakers and other playback equipment, turn off the power of all related equipment before making the connections.

Do not use excessive force when handling buttons, switches and controls. Do not use solvents such as benzene or paint thinner to clean the unit.

Always connect to an AC power supply that meets the power supply specifications listed on the rear of the unit. Export models: always insure unit is wired for proper voltage. Make certain grounding conforms with local standards.

YOUR AMPLIFIER IS LOUD! EXPOSURE TO HIGH SOUND VOLUMES MAY CAUSE PERMANENT HEARING DAMAGE!

Your Mesa/Boogie Amplifier is a professional instrument. Please treat it with respect and operate it properly.

READ AND FOLLOW INSTRUCTIONS OF PROPER USAGE.

OVERVIEW: FRONT PANEL (Continued)

CHANNEL 2 is the transitional channel between the low gain sounds of CHANNEL 1 and the high gain fury of CHANNEL 3. This channel contains the biggest differences between modes and there is definitely dialing required as you toggle through the voicing Modes. A stripped, British-inspired EDGE (switch up) unleashes low to mid gain aggression. Low mids are added for a thicker, throatier CRUNCH sound that travels up the gain scale while retaining a tight attack. And finally, MARK I flips the architecture to arrive at the iconic high gain voice that put MESA on the map back in 1970 with the little Boogie amp. This creamy voice is infused with thick bottom end and works great for fattening up single note solo sounds. You may want to run the BASS control very low (off to 10:00) when the GAIN is high in this mode to retain the best attack characteristic and avoid flubbiness. There is also a NORMAL/THICK switch that affects the MARK I Mode only to add extra gain in the mids for added single note focus.

CHANNEL 3 goes on from there to encompass the best of the MARK Series Overdrive sounds. Beginning with the MK II C+ (switch up) the sound is pure, blistering focus and this is the classic Boogie voice of the 80's that became the foundation for players like John Petrucci, James Hetfield, Kirk Hammett, as well as a staple for L.A.'s first call session players of the day Steve Lukather, Mike Landau, Dean Parks and many more.

The classic "V" curve on the Graphic EQ became an integral part of this sound and went on to be the sound of choice for some of the hardest hitting Punk and Hardcore bands of the 90's and 2000's and is still currently used by many top acts. The original II C'S bring many times their original selling price - if you can find one - and this faithful recreation of that burning sound is the cornerstone of CHANNEL 3. The MARK IV is also represented here in FAT (toggle center) where a dose of thick midrange gain is added combined with a rounding out of the upper harmonic peak. Finally EXTREME (switch down) unleashes all the aggression and attack of this circuit for a full gain assault that cuts through any mix. (Beware, the volume jumps up when EXTREME is selected.) There is also a NORMAL / BRIGHT switch included that affects all three Modes in CHANNEL 3.

EQUALIZER:

The on-board 5 Band Graphic EQ has been an iconic trademark of MARK Series Boogies since they first appeared on the MARK I back in 1970. The shaping power of this feature can't be denied, especially when combined with the MARK II's tight, focused gain sound. In the '80's the classic "V" setting of the EQ on MARK II and III models became a new sound in Heavy Rock and etched the on-board Graphic a place in Rock history.

While the **MARK V** Tone Controls are accurate and effective over a wide range, they come earlier in the signal chain and can only achieve so much shaping before they produce possible imbalances in certain Modes. (One example might be the Bass Control in Channels 2 and 3 - where in the MARK I and MARK II-C Modes - too much bass dialed up early in the preamp will cause the sound to be tubby and unfocused.

The Graphic EQ comes at the very end of the signal chain so you can shape the final sound with the only consideration being how much of a certain frequency your speakers, cabinets - and ultimately your ears - can handle. (Extreme settings of the two lowest Bands - 80Hz and 240Hz will use up power quickly and overall headroom will be affected, especially in the 50W and 10W settings of the Channel Power switch).

Each Channel is fitted with a mini-toggle to select the 5 Band Graphic EQ, but the fun doesn't stop there. The **MARK V** gives you the choice of two ways to utilize the power of the Graphic EQ for each Channel!

The mini-toggle within each Channel (center mini-toggle) allows you to decide whether you want the EQ on all the time in that Channel - EQ ON (toggle up), off all the time in that Channel - EQ OFF (toggle center), or activated by the EQ button on the Footswitch - EQ FTSW (toggle down).

A separate mini-toggle for each Channel located in the left side of the Graphic EQ section allows you to select whether you will use the actual SLIDERS (toggle up) to shape your individual EQ curve or, a PRESET contour (toggle down) based on the ever-popular "V" curve. The PRESET Mode is fitted with a PRESET DEPTH control that allows you to dial in the right amount of the PRESET contour

OVERVIEW: FRONT PANEL (Continued)

for each Channel's sound. For example, you might want to use the SLIDERS selection on Channel 3 to craft your own signature lead sound and two different mixes of the PRESET setting on Channels 1 and 2 for your clean rhythm and crunch sounds.

The ability to choose between these two options when assigning the Graphic EQ to your sounds gives you ultimate flexibility when dedicating the Channels. By combining subtle blends of the Tone controls with the EQ options, virtually any sound you can imagine is at your fingertips. Shaping power like this is what the *MARK V* is all about and another reason to smile, knowing you've made an investment in your long-term musical journey. This is one instrument that can keep pace and grow with you as you evolve, helping you to reach your full potential as a player.

POWER: MULTI-WATT™

The bottom 3 position mini toggle in each Channel (lower left corner) is the MULTI-WATT™ Power feature that determines the amount (wattage) and type (configuration) of power each preamp Channel will be coupled with to create a classic sound. Any amplifier's sound is 50% preamp and 50% power, so this switch is responsible for a large part of a given Channel's personality and feel. The choices repeat for all 3 Channels and they are 90 W, 45, and 10 W. Using the switch is simple... just select the power you want for each Channel, keeping in mind that the greatest headroom, focus and authority will always be found in the 90 watt position. That's how to use it, but for those who want the full story, here it is.

Since 1981 Simul-Class™ Power has been the heart and soul of the MARK Series amplifiers, imparting its sweet, musical character onto any sound in the vast library of the now classic MARK legacy. Cleans that shimmer with transparent layers of sweet delicate highs, while the bottom end breathes a warm fundamental under a bed of rich low mid ambience. Never harsh - always fat, the Simul lead tone is the quintessential single-note solo sound that is best described with a human trait...vocal.

This patented way of wiring an output section combines two pairs of power tubes with different bias settings and operating parameters to arrive at a blend that showcases the best attributes of both.

Talking about amplifier operating classes is too complex a topic to fully cover in this user manual however our booklet "Class A: Exposed and Explained" does a pretty thorough job and is available on-line at <http://www.mesaboogie.com/US/Smith/ClassA.htm> .

In simplified terms, our Simul-Class output comprises two dissimilar pairs of power tubes operating *simul*-taneously. One pair operates more toward Class A for tone while the other pair runs the traditional Class AB to provide the extra horsepower needed for clean headroom. Since its introduction in 1980, Simul-Class has evolved and improved, providing more power while still eliminating any trace of harshness.

In the Mark II-C+ the Class A pair was permanently wired in Triode configuration and in the *MARK V* this can still be achieved (for Channel 3 only) via the rear panel toggle switch. By reducing the tubes' power sensitivity, Triode wiring pushes the pair even further into the Class A region. This results in more dynamic compression and greater harmonic spread for the ultimate single-note fluid sustain but it does reduce the clean headroom substantially.

So let's quickly go through the power levels: The 90 WATTS position is the full Simul-Class mode with all four 6L6s combining the two different bias settings to deliver the maximum power and headroom. It is substantially sweeter and warmer and a little more scooped than a standard 100 Watt amp yet it has plenty of punch and authority without any harshness.

45 WATTS turns off the outer pair of 6L6s so only the middle two are running. These are the ones with the lowered bias so, while they are still Class AB, their Class A region is extended. In Channel 3, they can be switched to run in Triode configuration which cuts their clean headroom roughly in half.

Combining these two opposite styles of wiring in one amplifier gives you the best of vintage and modern amplifier styles. Headroom and power are there when you need it... but there is always a naturally pleasing and musically curvaceous quality to the sound that

OVERVIEW: FRONT PANEL *(Continued)*

is magic to your ears and to your hands. Simul feels great and is inspiring to play!

10 WATTS reconfigures the whole set of 6L6s so that the two nearest the 5U4 run pure Class A, single-ended—no longer push-pull. This is the ultimate low wattage output circuit that duplicates the essence of the best really old vintage circuits. Here, the second harmonic (an octave above the note played) is NOT cancelled out (as it is in push-pull circuits) and provides a magical halo surrounding the notes. Onset of clip is so gradual that it's hard to pin down the transition from clean to overdriven.

These three power choices give you ultimate flexibility as to the styles and venues the **MARK V** can adapt to instantly and in fact, it's like having three separate amps in one case - each having the perfect amount of power for a different application. And when you combine the power of the separate PREAMP Channels, the combinations of EQ and the POWER options, you have the most comprehensive collection of tube amplifiers ever brought together in one chassis. That's a bold statement; but after you spend some time exploring the combinations we're sure you'll feel the same.

OUTPUT & SOLO:

These two controls the overall output (volume) level of the **MARK V** when the EFFECTS LOOP switch on the Rear Panel is switched into the LOOP ACTIVE (switch up) position. With the EFFECTS LOOP in the HARD BYPASS (switch down) position the OUTPUT and SOLO are inactive and the overall volume levels will be determined by the MASTER control in the Channels. The EFFECTS LOOP adds a whole stage of amplification and the OUTPUT and SOLO come after this stage. The HARD BYPASS feature is intended for recording or solo playing environments where the balancing of the three channels is not so critical.

The OUTPUT control enables you to raise and lower the entire playing level of the **MARK V** without affecting the balance you have set between the Channels with the Channel MASTER.

The SOLO control is a footswitchable Master Volume for the whole amp that is wired in parallel to the OUTPUT control. This allows you to dial up a preset amount of boost and switch to it when it's time to step out for solo passages or any time you want to showcase a part. Simply set your desired overall playing level with the OUTPUT, Select SOLO on the **MARK V** Footswitch and set the desired increase in volume level with the SOLO control.

NOTE: The SOLO control may only be used to increase the volume beyond the level of that set by the OUTPUT. You cannot use the SOLO to switch to a level lower than that set by the OUTPUT Control.

NOTE: Check the setting of the SOLO control before switching to it as it may be set high and cause a shocking increase in volume.

The STANDBY shuts down part of the high voltage to the power tubes so that they can rest at idle without wear. It provides a start-up procedure (follow the Cold Start procedure... wait at least 30 seconds after powering up with the POWER switch before turning the STANDBY to ON). This reduces the shock on cold power tubes and increases their life. The STANDBY is also great for muting the sound during speaker changes and should also be used to cool the amp down during set breaks or when swapping tubes.

A built-in variac is included on the POWER switch so that you may run the entire amp on a reduced voltage "brown-out" condition. This reduced voltage changes the sound and feel of the entire amplifier. SPONGY Power scoops the midrange and increases the sag to achieve a more vintage, looser, easier-to-clip character. FULL POWER (BOLD) delivers maximum headroom, focus and punch and is considered the "normal" mode of operation.

OVERVIEW: REAR PANEL

A four-position CHANNEL SELECT rotary control is provided to access the 3 Channels when the Footswitch is not connected (in the studio) or available. Simply select which of the Channels you wish to play using this control when the footswitch is not in use. When the Footswitch is to be used, select the position to the far right (when facing Rear Panel) labeled FT SW and insert the DIN connector on the Footswitch Cable into the FOOT SWITCH jack on the right side of the Rear Panel.

A five-position rotary LOOP ASSIGN switch is provided to assign the EFFECTS LOOP to any or all of the Channels or, select FTSW to trigger the LOOP on and off with the **MARK V** Footswitch. The EFFECTS LOOP must be in the LOOP ACTIVE position for the LOOP ASSIGN rotary to function

NOTE: Check the OUTPUT level setting before activating the EFFECTS LOOP with the LOOP ACTIVE / HARD BYPASS switch (near center of Rear Panel) to avoid damage to your ears, those of bystanders and to your speakers.

Four ¼" EXTERNAL SWITCHING phono jacks are provided for remote control of the **MARK V** Channels, EQ and SOLO control from a master (possibly midi controlled) switcher. This feature is extremely important if the **MARK V** is to be used in a live stage set-up where all amplifiers and processors are controlled under one keystroke from a programmable master switching device.

NOTE: The four EXT SWITCHING jacks respond to standard grounding type (tip to ground) latching (not momentary) logic. This switching logic is standard on most master switching units.

The EFFECTS LOOP is fitted with a HARD BYPASS feature that removes a whole tube (two stages) and all associated circuitry from the signal path for the purist who insists the most direct path to tone in the studio. When the EFFECTS LOOP is activated by switching to LOOP ACTIVE (switch up) there is an adjustable SEND LEVEL control to assure optimum performance with your processing devices.

NOTE: Remember that the HARD BYPASS removes the OUTPUT and SOLO controls from the signal path and the individual Channel MASTER controls become the overall volume level controls.

Individual REVERB controls for each Channel allow you to set the desired mix of the rich all-tube Reverb effect for each Channel without compromise. The REVERB effect can be taken in and out of the signal path with the REV button on the **MARK V** Footswitch.

A PENTODE / TRIODE mini toggle switch (located just under the CH 3 REVERB Control) allows you to choose the wiring configuration of the middle pair of power tubes in Channel 3 only. This is a feature that was popular on the MARK 4 and changes the personality of the attack and liquidity of the sound in the higher gain condition found in Channel 3. PENTODE produces a bolder, tighter voice that has a more pronounced midrange curve and is excellent for adding percussive authority to lower gain single note solo sounds. TRIODE softens the attack and scoops the mids a bit to create a more liquid, legato feel that really shines for high gain styles and faster playing.

Switchable Rectifiers makes its debut on the MARK Series for the first time here on the FIVE in the form of Rectifier Tracking . Channels 1 and 2 are fitted with individual mini toggles (located under the Channel 1 and 2 REVERB Controls) that allow you to choose between the tight, bold - higher headroom response of Silicon DIODES or the saggier, sweeter low-output looseness of TUBES in the 45 Watt Power setting only. The 90 Watt setting automatically selects the Silicon Diodes and the 10 Watt setting requires the Tube Rectifier to operate safely.

Two 8 and two 4 Ohm SPEAKER OUTPUTS are provided and with these jacks almost any speaker cabinet configuration can be accommodated. The **MARK V** is not overly sensitive to impedance mismatches, so feel free to experiment with different cabinet schemes without fear of damage to your amplifier. Different loads will change the response, possibly to your liking. An 8 Ohm load will produce the punchiest, tightest sound and the maximum headroom. Keep in mind that the (power) tube life will be increased by running either an 8 or 4 Ohm overall load.

OVERVIEW: REAR PANEL *(Continued)*

A ¼" TUNER OUTPUT is provided and a SILENT TUNING feature has been incorporated so you can tune the instrument on stage without bothering the band or audience. Simply connect your favorite tuner and tap the TUNE the button on the **MARK V** Footswitch and all sound to the Speaker Outputs is muted.

A SLAVE OUTPUT and SLAVE LEVEL Control allows you to capture the full sound of the **MARK V**, both preamp and power section, for a feed to processing racks and/or additional power amps (perhaps MESA Stereo Rack power) for big venue applications.

NOTE: Always start any SLAVE hook-up procedure by zero-ing out the SLAVE LEVEL Control to avoid possible damage to your speakers or your ears! In fact it is good practice to leave the SLAVE LEVEL Control set to 7:00 (OFF) when it is not in use to avoid accidents.

The FOOT SWITCH DIN jack (female) is conveniently located on the right side of the Rear Panel and accepts a 7 pin male DIN cable. Connect the **MARK V** Footswitch here.

The Cooling Fan is fitted with an ON/OFF switch to allow silent running in the studio or late night practicing in the lower wattage settings. We recommend leaving the FAN on whenever possible to increase the toneful life of your power tubes. Basically, if the sound doesn't bother you... leave the Cooling Fan on all the time.

Finally a BIAS SELECT switch is included that allows you to run EL34 power tubes in place of the stock compliment of 6L6's. The EL34 style tubes will produce a brighter, skinnier sound that will clip with a whole different harmonic content that can be nice, especially for recording where you may not need the Channel switching performance of all 3 Channels and can dedicate the amplifier to one specific sound. The 6L6'S will most likely perform better for a wide range of sounds and certainly sound fatter and richer on most all the sounds and produce the greatest clean headroom. Whichever tubes you prefer, MAKE SURE THE SETTING OF THE BIAS SWITCH MATCHES THE TUBES IN USE!

NOTE: ALWAYS CHECK THE BIAS SWITCH AFTER SWAPPING TUBES AND EVEN AFTER TRANSPORTING YOUR AMPLIFIER! THE BIAS SWITCH MUST BE SET FOR THE TUBES IN USE!

Now that you have had a bird's eye view of the **MARK V** and a little history on the origin of some of the sounds, let's start going through the sounds and getting more specific with the function of the controls and how they interact...so you can get busy crafting your signature sound!

GETTING STARTED:

1. After unpacking the amplifier, remove the plastic webbing from all the tubes (including the preamp tubes behind the row of big power tubes and the Rectifier tubes. While you're at it, check to make sure all the tubes are firmly seated in their sockets as some may have loosened a bit during shipping.
2. Connect the A.C. Cord to a grounded (3 pin) A.C. outlet.
3. Unpack the Footswitch from it's stored location (in combo's it's in a pouch fastened to the Back of the combo cabinetry) and connect the 8 pin DIN Footswitch cable to the FOOT SWITCH DIN jack on the right side of the Rear Panel. Select FTSW on the (far left) Rear Panel CHANNEL SELECT Rotary Control. NOTE: Do Not Force The Cable Into The Jack! When the 8 pins are aligned properly the connector will fit easily into the jack.
4. Connect your speaker enclosure to the proper matching impedance SPEAKER OUTPUT on the right side of the **MARK V** Rear Panel. An 8 Ohm load is preferable for your first experience with the **MARK V** as you will hear the full power potential and best Tonal balance. (Combo speakers are shipped from us with the speaker(s) connected to the 8 Ohm SPEAKER OUTPUT).
5. Flip the POWER Switch to the FULL POWER (up) position while leaving the STANDBY Switch in the STANDBY position for at least 30 seconds. This allows the filaments to warm up in the tubes before being put to use. Following this cold-start procedure every time you power up will increase the toneful life of your tubes.
6. If you intend to connect processing devices to your loop do so now and look up EFFECTS LOOP for proper connection and operation, although we recommend auditioning the **MARK V** without processing for the first time. If the Loop is to be in use set the OUTPUT LEVEL control on the far right of the Front Panel To 9:00 (or lower) to avoid damage to your ears or speakers and increase slowly to the desired level once STANDBY is lifted.
7. Follow the Sample Settings examples below and set the Controls at these approximate settings for a tour through your new world of TONE. Remember these are just a glimpse at the vast possibilities and are meant to give you a taste of one possible way to set up your Channels. Feel free to fine tune the sound as you go...you can't hurt a thing and you will be learning by feel...the best way.
8. Flip the STANDBY to the ON (up) position and enjoy the ride!

SAMPLE SETTINGS:

Below are a couple of different ways to set up the 3 Channels for Channel Switching choices. Remember, there are countless ways to set up the Channels and after reading the rest of this Guide, you will be well equipped and ready to dedicate the Channels to your needs quickly and effortlessly.

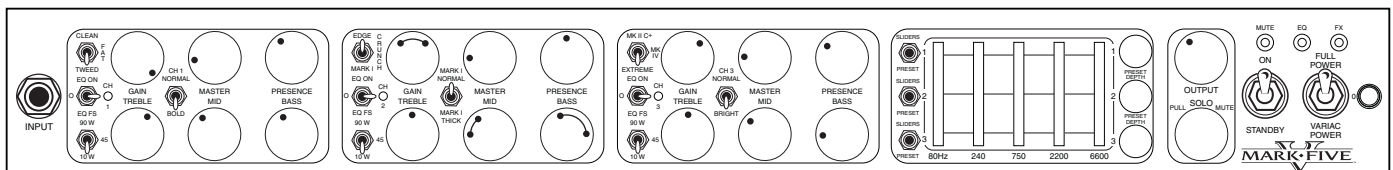
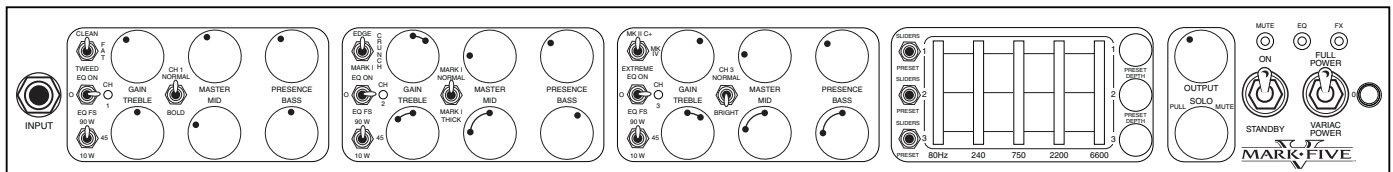

GETTING STARTED:

HELPFUL HINTS:

1. The Rear Panel CHANNEL SELECT Rotary control must be set to the FTSW (all the way right from rear) position for the Footswitch to trigger the Channels.
2. The OUTPUT and SOLO Controls are active only when the EFFECTS LOOP has been engaged and is in the signal path. When the LOOP is not in use the individual Channel MASTER Controls function as the overall master level controls. To engage the EFFECTS LOOP and use the OUTPUT and SOLO controls, flip the Rear Panel EFX LOOP mini toggle (left center, low) to the LOOP ACTIVE (up) position AND SET THE EFX SEND LEVEL CONTROL TO 12:00. NOTE: BE SURE TO START WITH THE Front Panel OUTPUT CONTROL SET at 9:00 (or below).
3. The SOLO feature can only be activated by the SOLO button on the FOOTSWITCH or the Rear Panel EXTERNAL SWITCHING jack. It is not active without the Footswitch connected as it is a live performance feature. Remember that the EFFECTS LOOP must be active to use the SOLO feature.
4. The SOLO feature can be used to achieve a footswitchable Boost above the level set by the OUTPUT control. It can not be used as a footswitchable “cut” or go below the level set by the OUTPUT.
5. The GAIN and TREBLE Controls are the most powerful tone shaping controls in each Channel and should be used with taste. They determine much about the attack characteristic and the overall personality of the sound in all the Modes. Many of the great sounds in all the Channels will find these two Controls in their middle ranges. Avoid setting the TREBLE high (above 2:00) when the GAIN is to be set high as this brings about the tendency for a slightly microphonic tube to ring or squeal.
6. When using high GAIN settings try the EQ for adding extra top end as it comes later on in the signal chain and will be less stressful on the preamp tubes in many cases. Remember the *MARK V* is a high performance amp in every sense. Just like a highly tuned car, you don't need to drive it “wide open” to have fun. You can get amazing performance in the middle ranges of all the controls. Yeah sure, there are times when you are going to run flat out...but just like the car needs special tires to run flat out, it takes a rare set of preamp tubes to do that all the time.
7. You will experience a volume increase when selecting the Channel 3 EXTREME Mode from the two prior Modes in that Channel. This is normal and a result of changing the negative feedback in the power section.
8. The PRESENCE is very powerful at shaping the voicing of high gain sounds in Channels 2 and 3 (and even TWEED in Channel 1). Set low it fattens and compresses the sound, making for a more voice-like focused note. Higher settings “open up” the sound and allow the full spectrum of harmonics to flow through. Use this control to fine tune your lead sounds after you have dialed the rest of the preamp controls to your liking.

GETTING STARTED:

9. Beware too high of settings on the BASS control in Channels 2 and 3, especially when the GAIN is set high. Too much BASS will produce a flubby, indistinct attack. In the MARK 1 Mode of Channel 2 it is perfectly respectable and even recommended to run the BASS control extremely low (8:30) or even “off” when the GAIN is set high (above 1:30). The Modes in Channel 3 can stand a little more BASS, but watch it there as well. A basic rule might be this; As the GAIN goes up...the BASS should come down.
10. The one exception to the prior warning is the Channel 2 EDGE Mode. Here you may want to run the BASS Control higher than on any other Mode in the amp. The preamp is switched around to focus the bass frequencies in a much higher region and therefore you can dial in more of it before the sound gets bloated.
11. The MARK 1 NORMAL / THICK switch in Channel 2 affects only the MARK 1 Mode (middle MODE SELECT toggle down). THICK adds gain in the lower midrange and fattens the sound for more voice-like single note soloing or more grinding crunch chord sounds.
12. The NORMAL / BRIGHT switch in Channel 3 works in all 3 Modes. NORMAL sounds more round, rich and warm and is a pure solo voice. BRIGHT lifts the veil, allowing a whole spectrum of higher harmonics to soar through unimpeded for that classic Boogie stacked harmonic spread.
13. The TRIODE / PENTODE switch (on the left center of the Rear Panel below CH 3 REVERB Control) only affects the wiring of the power tubes and the sound in Channel 3. It will soften the attack and make the strings feel more liquid in TRIODE and tighten the attack, add midrange punch and increase the headroom when set to PENTODE.
14. The RECTIFIER TRACKING switches (right center below CH 2 and CH 3 REVERB Controls) only allow switchable rectifier choices in Channels 2 and 3 in the 45 Watt setting. (Front Panel Multi-Watt Power Select switch located in lower left corner of each Channel). The tracking allows the choice of TUBE or Solid State rectifier in the 45 Watt Mode. Rectifiers are selected automatically: (Solid State) in the 90 Watt and (Tube) 10 Watt Modes according to their power requirements and associated sound styles.
15. Beware of setting the EQ (both SLIDERS and PRESET Controls) to extremes when using the Channel 2 MARK 1 Mode. Be especially careful of the 80Hz and 240Hz, as these two along with very high settings of the PRESET Control can dump excessive amounts of low frequencies into the mix. This, combined with the high gain settings of this Mode, can cause flub and mud in the sound and even damage lower wattage speakers if played at high volumes.
16. Speaker Impedance has a large sonic effect on the sounds as the **MARK V** power section is switched between its' three different Modes. We prefer a matching 8 Ohm speaker load connected to the 8 Ohm SPEAKER OUTPUT for the most balanced sound and overall performance in all 3 Channels. However, the Simul-Class™ Output Section is a mysterious animal and will produce some interesting and musical results when different loads are applied. One favorite is connecting the 8 Ohm speaker load to the 4 Ohm SPEAKER OUTPUT when using the 45 Watt (Half Power) setting. Feel free to experiment with different load combinations. You can't hurt your amplifier and you may discover an impedance scenario that, though is a technical “mismatch”, produces a unique response that fits your needs. The only penalty might be that your power tubes can wear a bit faster with certain load conditions, usually with mismatches in the low direction (4 Ohm load on the 8 Ohm OUTPUT).

GETTING STARTED:

17. Make Sure The BIAS SWITCH (far right facing Rear Panel) Is Set To Match The Tubes In Use...ALWAYS! It is a good idea to Check This Switch after each time you transport your amplifier as it may get bumped and accidentally switched to an improper setting. NOTE: Running the wrong BIAS setting can damage your amplifier and lead to unnecessary down time and costly repairs.

18. Your *MARK V* will sound better and feel better to play if you have at least one speaker cabinet (the combo or an Extension cabinet) touching the floor you are standing on while you play. The coupling effect and especially the transmission of bass frequencies will cause the amp to sound fatter and the strings to feel more substantial and tangible when the amp (or cab) sits on the floor. Wood floors (like stages) are really great! Let's face it... the guitar can be one of those weird instruments that rarely feels the same way two days in a row - night to night, from room to room...we can use all the help we can get. This usually helps... with the only exception being a stage filled with too many live mics...sometimes then you are forced to lift the amp to the coupling effect.

19. Try TWEED POWER (Front Panel POWER switch down) when you want to clip the two CLEAN Modes in Channel 1 at lower volumes. Using this in combination with the 45 and 10 Watt Power Modes can produce some sweet threshold-of-distortion, vintage break-up sounds.

20. Use the STANDBY switch every time you power-up, during set breaks, cable hook-ups and anytime you are not playing for a few minutes. Doing so will increase the toneful life of your tubes.

THE CHANNELS:

The three Channels of the *MARK V* are each extremely versatile and therefore it is not entirely fair to categorize them as to Rhythm, Crunch and Lead. Most players will initially assign Channel 1 to some sort of clean sound, Channel 2 to an overdriven rhythm or chording sound and Channel 3 to a single note solo sound. While there is nothing wrong with this scheme - and in fact the *MARK V* lays out nicely for this approach – it is also true that all three Channels are equally adept at all three types of sounds. In other words, Channel 3 can produce great crunch rhythm sounds, Channel 2 is capable of some nice clean-ish sounds and Channel 1 boasts some amazing solo sounds. So the lesson here is not to label the Channels as to style, and perhaps think of them more in terms of their individual gain structure. This type of thinking will help you to not limit yourself when searching for sounds and we encourage you to think outside the box and use your imagination when dedicating the Channels. The Five was created to be an instrument of limitless expression and possesses all the gain and shaping power to take you anywhere you wish to go in the world of Tone.

Here is a quick reference guide to the Channels and how they lay out in terms of gain structure. How you wish to assign them to your needs is up to you and discovering that... well that's where the fun begins.

CHANNEL 1:

Lowest gain of the three Channels. Two Modes CLEAN (switch up) & FAT (switch center) are structured for clean sounds. These two modes are well described by their names as in CLEAN is sweet, sparkling low gain beauty and FAT adds big low end and breathiness to this sound. These two have the greatest headroom and the most dynamic range and sensitivity. They are the least compressed and retain the fastest attack characteristic.

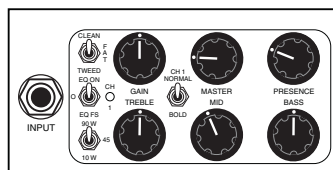

The medium gain TWEED Mode (switch down) is dedicated to pushed, overdriven “clean” sounds. TWEED increases gain in the low mids and adds fatness which creates a smoother sound when clipped. This added gain slows the attack a bit but in turn adds sustain and girth. A balanced dynamic content makes TWEED work equally well for both broken-up chording and urgent single note soloing.

CHANNEL 1: NORMAL / BOLD

This switch works globally in Channel 1 and offers two choices in voicing the mids and upper mids / lower treble region. **NORMAL** provides a balanced smooth response that shines for both shimmering sweet clean sounds and creamy soft-clip tones as the modes are driven harder with the GAIN control. No particular frequencies stick out in this position which creates a perfect base for rhythm work and makes NORMAL respond very well to further embellishment with either the Graphic EQ or the PRESET Contour.

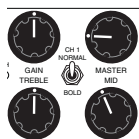

BOLD punches through with a pronounced bump in these mid and upper mid/ low treble frequencies that will allow you to cut through a dense mix and be heard. It also gives the impression of increased power and headroom as cleans sounds fly out of the speakers with immediacy and authority. Likewise overdriven sounds, especially in TWEED, willingly adopt the added attack and turn it into stinging aggression. Be sure to work with the TREBLE, MID and PRESENCE in the BOLD setting to fine tune these regions and optimize both the sound and the feel.

THE CHANNELS: (Continued)

CHANNEL 2:

This “Crossover” Channel contains both the lowest gain of the high gain Modes (EDGE) and one of the highest broad-spectrum gain Modes (MARK I). Channel 2 alone contains more types of sounds than many complete amplifiers and can be assigned virtually any task.

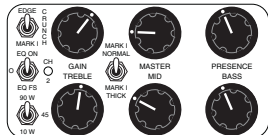

EDGE is the lowest gain Mode in Channel 2 and is EQ'd to be stripped, urgent and fast. Low end is tucked up higher and reduced slightly to increase dynamic response and increase attack speed. Works extremely well for classic Rock broken-up chording sounds in the medium GAIN range. GAIN set high produces articulate, biting single note sounds.

CRUNCH is the medium gain Mode and is filled-in and rounded-out with added low-mid gain and more bass at lower frequencies. It produces a smoother sound that is still tight and fast, but creates a wider footprint than EDGE. Dynamic response is still quick and accurate, but the added gain introduces the first hint of natural tube compression. CRUNCH also works equally well for both rhythmic chording and single note solo sounds that are overdriven, but not too saturated.

MARK I is the highest gain Mode in Channel 2 - equal in gain to any Mode in Channel 3 - and is behind the reason for not calling Channel 2 simply a “Rhythm” channel. This is the singing, soaring, roaring voice that put MESA on the map when it burst on the scene in 1970 in the little Boogie 1x12 combo. Increased gain in the entire spectrum creates a thick, rich wall of harmonic overdrive that produces maximum sustain and saturation. The MARK I sound is known for its huge low end and girth that can fatten single note sounds and create a voice that can not just carry, but propel a melody. This wall of gain can be shaped, not only to enhance single note sounds, it can be stripped back to create purring lower gain chording and Blues sounds as well. The higher GAIN settings produce amazing single note textures or, with the BASS and MID set low and the EQ kicked in, crushing heavy chord sounds.

MARK I : NORMAL / THICK

This two position switch re-voices the Treble frequencies to be either NORMAL (switch up) - higher and more sparkling or THICK (switch down) – lower and fatter in the upper midrange. This switch is active only in the MARK I Mode and does not affect EDGE or CRUNCH. Use **NORMAL** for lower gain chording and Blues work or anytime you want sweet top end and harmonic openness. Use **THICK** for added gain and girth to fill-out single note sounds and make high gain rhythm sounds grind harder. You can also think of NORMAL as being more “black face” era, and THICK voiced to more of a British amp vibe.

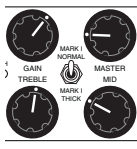

THE CHANNELS: (Continued)

CHANNEL 3:

This Channel is the overall highest gain in the **MARK V** and is dedicated to creating the best high gain sounds from the fabled MARK II-C+ and the MARK IV. Though the entire channel is aimed at high gain sounds, many expressive and dynamic medium to low-gain sounds can be found here with the GAIN control set lower (below 12:30). Again, this channel defies classification as to style and is extremely versatile for both low and high gain, chording and single note sounds.

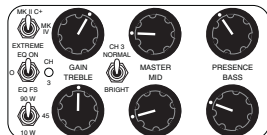

MARK II C+ is exactly that. This Mode is a faithful – down to the last detail – recreation of the LEAD Mode of this legendary circuit. Blistering focused gain and explosive attack that gives way to morphing harmonics are its soulful signature and after 20 years, these sounds remain at the forefront of Rock. The tight mid-punch focus of this sound provides an open canvas for coloring with the Graphic EQ and the classic “V” setting has become a staple ingredient of the II-C high gain sound for heavy music.

MK IV is a faithful re-creation of the MARK IV’s Lead Channel. Because of the vast options in configuring this channel on the MARK IV – combined with the fact that the MK II C+ Mode covers a wide range of brighter sounds, we have configured this Mode for a slightly warmer sound. The MK IV Mode has a substantial increase in midrange gain that creates the impression of a roll-off in the upper harmonics resulting in a huge, wide sound. It’s a different flavor of fatness as compared to Channel 2’s MARK I Mode, as here the midrange is voiced higher and stays tighter. Because of this characteristic the graphic EQ does an amazing job of shaping this sound into whatever you want it to be. The EQ doesn’t have to compete with the increased low end early in the preamp of the MARK I Mode and can be used to dial in some incredibly big sounds that won’t get flubby.

EXTREME is exactly what it sounds like...extreme! This Mode also takes its architecture from the MARK IV, but is voiced almost opposite of the MK IV Mode in this Channel. Forward, aggressive, tight and fast are its signature and it is the highest gain and loudest of the **MARK V**’s nine Modes. You will experience a substantial increase in volume when selecting EXTREME from either of the other two modes in Channel 3... and this is after we padded it all we could without affecting the Tone.

Use this mode when you want crushing impact and stop-on-a-dime dynamics. EXTREME is most suited for heavy styles where maximum gain and lightning fast attack are the order of the day.

NOTE: Increased sensitivity in the power section in the EXTREME Mode causes more background noise because the power amp and driver are “listening harder”. This is normal and no cause for alarm.

CHANNEL 3 : BRIGHT / NORMAL

This two-position switch determines the amount of upper harmonics present in the sound of all 3 Modes in Channel 3. Some sounds bring forward the action of this switch more than others, depending on the amount of top end in the sound to begin with, but it adds or reduces brightness at its location in the signal path in all Modes of this Channel. For example; you will hear its action more in the MK II C+ Mode than you will in the MK IV (FAT) Mode - because the high frequencies are more rolled off and recessive in the MK IV Mode and therefore there are less of these frequencies present for the BRIGHT switch to bring forward.

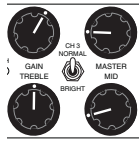

In the **BRIGHT** position (switch down) the sound will be infused with an upper harmonic halo around the note(s). This added top end becomes more apparent as the GAIN is increased, especially in the MK II C+ and EXTREME Modes where the BRIGHT circuit has more highs to work with. The BRIGHT position is great for adding harmonic grind to high gain chording sounds in these two Modes. It lets these highs pass at a specific earlier stage in the preamp so that the PRESENCE and GRAPHIC EQ, can be used to blend and shape them down the line.

In the **NORMAL** position (switch up) this region of upper harmonics is rolled off, creating a darker, warmer blend that works well for single note soloing. The NORMAL position is great for adding a feeling of girth and fatness in low gain sounds and removes unwanted sizzle and buzz that can result from low output pickups in high gain settings.

THE CHANNELS: *(Continued)*

NOTE FROM THE AUTHOR: Douglas West A.K.A Tone Boy

Randy wanted me to give this bit of info to you personally, even though it felt a bit funny to write "I" as opposed to "we", so that my personal experience could validate the source.

From 1982-1991 I was the person who tested every finished amplifier here at MESA - along with my other duties in R&D, Customer Service and writing Owner's Manuals. I worked side by side with Randy (playing guitar and asking for more Tone and features) on the revision of the MARK II B that would eventually become the MARK II C+... as well as every amp since. During that time is when I was affectionately given the nickname Tone Boy for my relentless pursuit of a certain attack/morphing-harmonic characteristic I was hearing in my head. I was driving Randy crazy then - and I must take the time here and now to give him my deepest thanks and utmost respect for listening to my ranting and raving. He didn't even play guitar - but he heard me - and had the belief in this quality I described just as deeply as I did. And even better - he found a way to deliver it! From myself, and all of us guitarists who have made this sound our own... Thank You!

Anyway, as to how this affects you as a **MARK V** owner, there is some inside info you need to know to get the most out of Channel 3. This especially applies to you MARK II C+ and MARK IV owners who will be looking for your old amps sound in this Channel and probably even be comparing the **MARK V** side by side to your II C+ or IV.

Back when I was testing II C+'s every day in the burn-in room, I always thought the non-graphic amps had a certain attack and purity to the sound that the amps that had Graphic EQ on them just didn't have. There was an urgency and bold punch to the sound...they seemed tighter and more cohesive. Now granted, we made far more amps with the on-board EQ than without...probably 70% had the EQ, but not many people had the opportunity to compare day-in and day-out as I did. The EQ model had the shaping advantage... no doubt about it, and certainly all the sounds that II C+ are famous for were created with the EQ being an integral part of that sound, but when it came to the straight sound - no EQ - the non-graph model always got to me with it's speed and authority.

So it was that I came to be the obsessive/compulsive owner of no less than 8 of the II C+ Simul-Class™, Reverb (non-graphic) heads. I hand picked these as being the best sounding amps - for me - out of the thousands of II C+ we made. Out of these eight amps I immediately found my favorite - which I dubbed "His Highness the C-ness" and which I used as a reference model to have our Chief Tech and Archival Guru Michael Bendinelli, copy exactly on the other 7 amps. Everything was measured and scrutinized (pot values, resistors, caps, transformers swapped, etc.) and duplicated, and in the end... all 8 sounded alike. Regardless, His Highness was my golden reference for MARK II C+ Tone and our R&D reference amp for many MARK Series amps to follow, including the MARK IV.

Over the next two decades I found the need to part with some of these magic amps for studio gear and such and always I gave my close friends first crack at these - but His Highness remains to this day a mysterious, sweet-singing, fire-breathing beast of an amp.

So naturally when it came time to do the Channel 3 sounds of the **MARK V**, we went to the Oracle - His Highness The C-ness - and asked permission to pay our respects to His Golden Tone...He granted, and the work began.

In our endless comparisons of many original II C+'s - both EQ and non-EQ samples - alongside this golden reference, we discovered that I wasn't just Tone-dreaming. There was actually a difference between the EQ model and those non-EQ models. It all came down to a coupling capacitor at the end of the EQ circuit that feeds the driver. In the EQ model, it was a great big cap that let a lot of sub-low pass, slowing down the sound and making it fatter. In my amp - a non-EQ version - this cap was smaller and didn't let as much sub-low through - which speeds up the sound and makes everything tighter and more urgent. There it was, a simple part...but it made all the difference in the time domain.

Yet there were so many more of these slower, fatter sounding EQ versions out in the world... that many more people were used to

THE CHANNELS: *(Continued)*

hearing as their reference. It would not do well to set the **MARK V** permanently to this faster, tighter way. Too many players would have a tough time adjusting and when they compared the two amps side by side, the V would sound faster and tighter yes, but also stripped of sub-low and therefore maybe not as fat in comparison to their trusty II C+ Graphic model or MARK IV - which also had the bigger coupling cap. What to do at the crossroads? What we do is take more time... and go down both roads.

So in the **MARK V** we gave you both fast and fat.

The II C+ Mode in Channel 3 uses this smaller coupling cap to deliver the tightest attack and fastest response in the time domain. In addition you get the bonus of having this Mode work incredibly well with the EQ, because the lack of sub-low at the end of the preamp means you can add more low frequencies with the EQ before the sound gets flubby. So all you II-C and MARK IV guys might like this characteristic even better. You can get high gain sounds with the EQ even tighter than ever before!

The MK IV and EXTREME Modes utilize the bigger coupling cap to add sub-low and slow down the attack for a bigger, fuller slow-hand feel that is absolutely huge. You will find that you have to be a little more careful with the 80 and 240Hz Sliders when dialing in low end with the EQ because more low end happens earlier, but the sound is definitely bigger.

So if you want it tight, urgent feeling with the fastest attack and maximum focus, use the MK IIC+ Mode. If you want the fattest, warmest, biggest sound and don't need the super fast response, use the MK IV and EXTREME Modes.

Oh, and by the way...Mission Accomplished! The Oracle, His Highness The C-ness, now shares the Throne Of II-C Tone with the **MARK V**. Of course the **MARK V** rules in so many other sonic Kingdoms that it has it all over the II-C for all around diversity of sounds and incredible gig-ability.

NOTE: II-C+ and MARK IV OWNERS

*If you do end up doing a side by side with a II-C+ for the LEAD Mode, you must use the II-C+ and **MARK V** set like this for a fair comparison:*

SET II-C+ As Follows:

VOLUME (Far Left) control Pulled (Bright On) and set to Approx. 7 $\frac{3}{4}$. (This stage in the **MARK V** is set to a sweet spot we found from measuring many amps and control deleted).

LEAD DRIVE Control Pulled and set to desired setting

All Tone Controls set by ear as close as possible (we measure each pot and set both exactly with an ohm meter).

PRESENCE set to desired setting. (0 or 10 is the most fair for comparisons sake and removes any pot variance).

GRAPHIC EQ Off (Bypassed)

SET **MARK V As Follows:**

GAIN control set by ear and relative "clock face" setting to II-C LEAD DRIVE.

Tone Controls set by ear and relative "clock face" setting as II-C Tone Controls. (Remember that II-C BASS control is in the 2nd position - MID is 3rd on II-C whereas **MARK V** is TREBLE, MID, BASS).

Channel 3 BRIGHT switch in the BRIGHT (switch down) position.

Rear Panel Channel 3 TRIODE / PENTODE switch set to TRIODE (switch down).

Rear Panel EFX LOOP switch set to ACTIVE (switch up).

THE CHANNELS: *(Continued)*

CAUTION: *The EXTREME Mode is LOUD in both these amplifiers...Use Care and Zero out the OUTPUT Level Controls before beginning this comparison*

SET MARK IV As Follows:

Channel 3 (LEAD)
LEAD GAIN (FAR LEFT) Pulled and set to 7 ¾
LEAD DRIVE Pulled and set as desired
Channel 3 (LEAD) Tone Controls set as desired.
Pull All Controls (unless comparing EXTREME - then leave LEAD PRESENCE Pushed In = EXTREME)
PRESENCE set as desired (0 or 10 is most fair and removes pot variance)
Rear Panel TRIODE / PENTODE switch set to PENTODE

Set *MARK V* As Follows:

Channel 3 set to MK IV or EXTREME Mode (Make sure set the same as MARK IV)
GAIN set to match relative "clock face" setting of numeric LEAD DRIVE setting on MARK IV.
Channel 3 Tone Controls set to match relative "clock face" settings on Mark IV.
Channel 3 BRIGHT / NORMAL switch set to BRIGHT (switch down).
Channel 3 PRESENCE set to relative setting on MARK IV.
Rear Panel TRIODE / PENTODE switch set to PENTODE (switch up).
Rear Panel EFX LOOP switch set to ACTIVE (switch up).

You cannot hear the MK II C+ Mode in the *MARK V's* response in an older MARK Series model because the coupling cap at the end of the EQ in those amps is simply too big and is adding too much slow-lows to be a fair comparison.

NOTE: *These comparisons are as close as possible regarding the setting and configuration of the circuits. When doing these types of tests it is important to take into account that the power tubes, preamp tubes, transformers and even the caps and resistors may be different depending on availability at the time of construction.*

FRONT PANEL: MODES

THE MODES:

Now let's take a look at the Modes individually to learn more about their applications and focus so that you can dedicate the Channels to what best suits your needs.

CHANNEL 1:

This is the lowest gain of the three Channels in the *MARK V* and will cover all your needs for clean rhythm and solo styles as well as and slightly driven chording sounds. As with the Modes in each of the Channels we start with the slimmed down (skinnier), tighter voice of CLEAN and move up the girth scale to FAT and finally to the slightly higher mid-gain of TWEED.

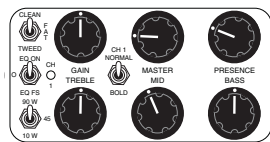

CLEAN is derived from a blend of our best MARK series clean sounds taken from the MARK IV and is perfect for rhythm comping in an ensemble environment where the guitar has to fit in a defined spot in a more complex mix. It is also extremely accurate in the time domain and has a balanced blend of tight low end to the sparkling, immediacy of the top end. This mode also clips great in the 45 and 10 watt power modes with its' well balanced, more stripped nature.

FAT stands in sharp contrast to this with a big breathy bottom that extends down into the sub-low region and this adds air to the entire spectrum as the top end gets more bubbly and spacial. This sound pays tribute to the best of the black face inspired sounds and the circuit relies heavily on architecture from the INPUT 2 of the original MARK I and our popular *MARK V* CLEAN Mode. FAT excels at big, featured chording parts and single note clean soloing and is also a great choice for clipped sounds (with the BASS control set low) in the 45 or 10 watt power mode.

TWEED adds a boost in the mids and rolls back a little top end to create a sound that punches through a mix with mid authority and clips with a more rounded vocal quality. TWEED works great for lower gain crunch rhythm parts as well and you can add a healthy dose of top end cut with the PRESENCE control because there is less upper harmonics to get hashy or buzzy.

CHANNEL 1 VOICE SWITCH - CHANNEL GLOBAL:

NORMAL / BOLD:

This switch works globally in Channel 1 and offers two choices in voicing the mids and upper mids / lower treble region. **NORMAL** provides a balanced smooth response that shines for both shimmering sweet clean sounds and creamy soft-clip tones as the modes are driven harder with the GAIN control. No particular frequencies stick out in this position which creates a perfect base for rhythm work and makes NORMAL respond very well to further embellishment with either the Graphic EQ or the PRESET Contour.



BOLD punches through with a pronounced bump in these mid and upper mid/ low treble frequencies that will allow you to cut through a dense mix and be heard. It also gives the impression of increased power and headroom as cleans sounds fly out of the speakers with immediacy and authority. Likewise overdriven sounds, especially in TWEED, willingly adopt the added attack and turn it into stinging aggression. Be sure to work with the TREBLE, MID and PRESENCE in the BOLD setting to fine tune these regions and optimize both the sound and the feel.

FRONT PANEL: MODES (Continued)

CLEAN (Mode Select Switch Up):

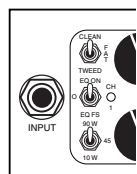

CLEAN is derived from the classic MARK series circuits and puts emphasis on tight, focused clean rhythm and articulate single note playing. This mode has the greatest clean headroom of any mode in the amplifier, and though it can be pushed to clip at extreme settings (4:00 – 5:30), it will remain tighter and somewhat stiffer than it's FAT counterpart when used for this application. The good side of this stiffness is that the BASS control can occasionally be set higher than when going for clipped sounds in FAT - because the overall personality of CLEAN is stripped of the sub-low frequencies that can be a challenge when looking for aggressive threshold rhythm sounds.

CLEAN works very well for agro and brash clipped chording sounds, especially when the Power Select switch is set to 45 watts and the PRESENCE is run a bit high (1:00 - 2:30). Check out this vibe for Punk or super fast Rock rhythm styles where you need aggressive almost-clean sounds that will start and stop instantaneously.

CLEAN shines for chording and arpeggiated work with its crystalline top end sparkle and high harmonic openness. The low end is tucked up higher so that it adds breath and warmth, but doesn't go too low so it won't get too big or sluggish and get in the way when a groove calls for precise rhythmic note durations. CLEAN is amazing for skanky Funk rhythm or burning Country picking.

The midrange frequencies are also a bit higher in frequency in comparison to the FAT mode, enabling CLEAN to deliver a percussive attack that stays tight and has maximum impact in a range that cuts and protects its territory in a complex mix. Playing with these higher mids can be a powerful way to shape the CLEAN mode as the role they play either brings the sound forward – even in the time domain making it seem faster - or lends a recessive, more relaxed quality to the sound - making it seem slower. Experiment with the BASS and MID controls as you will learn to tune the attack, width and girth of the sound in CLEAN to match the style and tempos you play most.

FAT (Mode Select Switch Center):

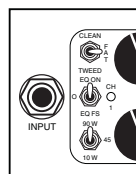

FAT comes from the MARK I Input 2 (which is where our popular *MARK V* got it's CLEAN voice as well) and is in every way opposite to the tight, bright voice of CLEAN.

This circuit pays homage to the early Black Face era circuits pioneered by Leo Fender and has become tightly interwoven into the fabric of classic Rock and Blues sounds.

Sweet shimmering highs that soar high enough for angels to hear, yet ring with bell-like authority for the rest of the band. Proud mids that are punchy and tight, yet are low enough to carry weight and add girth. Big, airy lows that start at the center of the earth and bring the big fundamental to get the party started in a hurry. These qualities produce an easy to play feel on the strings that invite you in...coaxing you to play your best and of course always...with soul.

FAT works great for chording and rhythmic work, but in contrast to the CLEAN mode, FAT sings with a huge, lush voice that fills-in a mix and casts a halo of harmonic richness around the entire instrument. The sonic footprint is much wider and can carry a part such that it becomes the backbone of a song without any processing.

The gain structure of FAT is tapered such that it's more suited to threshold and clipped sounds, with more gain coming up sooner on the GAIN Control. As FAT is pushed toward clip, the bigger cathode values in the preamp deliver a smooth, rich break up that is usually preferable for both smeared chording and bluesy single note solo work. The extra gain fills in all the jagged edges in chords and lends girth to the single notes such that it becomes most players go to mode for all in-between sounds. FAT is really useful in the studio for both clean and slightly driven parts, where you want to have a big sound and retain all your dynamic nuances. This is especially true in the 45 and 90 watt settings of the Power Select switch, where the power section can deliver dynamic differences effortlessly.

One important thing to keep in mind is that the lower centering of bass frequencies makes it possible to overload both the preamp

FRONT PANEL: MODES (Continued)

and speakers quite easily by setting the BASS and MID Controls in their higher regions (above 11:30). Even the power section is not immune - as the extra lows will use up power quickly (it takes more wattage to amplify low frequencies) and along with premature clip, you will create a flubby, indistinct sound that is not very pleasing. Follow the simple rule we suggested earlier in the Helpful Hints section of the manual; As the GAIN control goes up – the BASS (and MID in this case) control should come down. This will help you avoid overloading your rig with lows and tubing-out your sound.

NOTE: Lower frequencies produced in the FAT mode can create a bottom heavy, flubby sound that can overwhelm your speakers and eat up headroom if the BASS control is set too high, especially in combination with high GAIN settings. It is normal - and in fact suggested - to run lower BASS (and even MID) settings (10:00- 7:30/OFF) in the FAT Mode as the GAIN is increased.

TWEED (Mode Select Switch Down):

TWEED takes a step up on the gain scale and provides the perfect blend of a clean channel – with dynamic responsiveness and top end openness intact - and the warm beginnings of a mid-gain channel that can provide some sustain and drive. It is by no means a high gain or lead channel, but it is the highest gain Mode in Channel 1. TWEED creates a smooth transition from the icy attack of CLEAN and the warm bloom of FAT to the higher gain region covered by the 3 Modes in Channel 2.

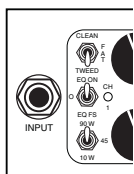

This Mode shares some circuitry and sonic characteristics with both the Mark IV's Rhythm 2 Mode and the TWEED Mode on our Dual Rectifier Road King and Roadster amplifiers. The name harkens back to the prized vintage voice of the earliest Leo Fender Tweed era circuits that early Rockers cranked all the way up to obtain a raw and beautiful clip, casting these amps firmly in the mantle of classic Rock sounds.

In the lower and middle ranges of the GAIN control, an alternate clean sound delivers a mid enhanced focus and punch that works well for clean parts that need to be in your face. If you want to reduce this effect simply run the MID control low (8:30 – 10:30) and soften the impact of these extra midrange frequencies. This trick creates a great transition up the forward-clean-sound scale. Another great sound is created by using either the SLIDERS or the PRESET EQ with TWEED to soften the mids and bump up the lows and highs...the sound is aggressive and big and can be used for many styles!

TWEED excels at delivering the in-between, almost clipped rhythm sounds that are at the forefront of popular music with an urgency and brashness that cuts through the mix and commands attention. These styles will probably benefit from setting the GAIN and TREBLE Controls pretty high (2:00 – 5:00) and then adding cut and urgency with the PRESENCE Control. It also works great for Blues and Roots style rhythm playing under the same settings scenario but try adding a bit more BASS and MID and rounding it out with a lower PRESENCE setting.

A very touch sensitive and dynamic solo voice is also on the menu with TWEED - but the GAIN and TREBLE will have to be very high (4:30 – 5:30) to achieve the gain needed to be vocal and hang notes. The Presence will usually want to be low ((7:30 – 9:30) to obtain a round, smooth quality, especially since the TREBLE needs to be high to milk all the gain you can get out of it.

The GAIN/ BASS relationship rule still applies and particularly when it comes to single note solo sounds and chording sounds that need to have an instant start/cutoff characteristic; As the GAIN goes up – the BASS should come down.

And finally, don't forget to experiment with TWEED in combination with the two lower power settings (45 and 10W) of the MULTI-WATT Power Assign switch for some amazing pre/power clip concoctions. The added mid focus and punch inherent in the voicing of the TWEED Mode retains its attack characteristic even while the power is sagging to create some wonderful sounding/feeling break-up. These sounds work equally well for both chording and single note work and seem to give back in spades all you put in and more. Old school fun for sure!

Oh yeah, one last thing. Don't be shy about using the EQ, either SLIDERS or PRESET, when cranking the GAIN for some of the

FRONT PANEL: MODES (Continued)

clipped sounds in TWEED. The shaping power of the EQ can create some amazing Rock rhythm sounds that are tight and aggressive, but huge and blooming at the same time. That combination of not too much gain in the preamp (as compared to the higher gain modes in Channels 2 and 3) and the powerful EQ curves equip you with some kick ass, forward, dynamically-endowed sounds that can really drive the band.

NOTE: All the Modes in Channel 1 work well with Front End Overdrive Pedals between the guitar and the **MARK V's** INPUT. While CLEAN and FAT will overdrive nicely, TWEED will produce the greatest amount of saturation when the first tube stage is hit with the bigger signal produced by a pedal. When using TWEED at it's higher settings in conjunction with a Front End overdrive device, it may be possible to push the preamp tubes into a microphonic state that could cause noise or squealing. Dial back the GAIN, TREBLE and /or PRESENCE a bit to reduce the strain on the preamp tubes. It may also be necessary to reduce the pedal's master output control to obtain a stable operating condition. None of this will harm your amplifier in any way, and is a minor inconvenience. If your sound depends on this scheme and you do experience microphonic noise, it may require that you obtain several very stable preamp tubes (SPAX7) from us and swap out the first couple stages one at a time until you find tubes that can operate under these more demanding conditions. The **MARK V** leaves the factory with tubes that can handle most anything the amp can throw at them, but pedals can put an additional load on the tubes. Call us and ask to speak with a Product Specialist and they can assist you in obtaining these tubes.

CHANNEL 2:

Channel 2 is not only the “crossover mode” between the lower gain of Channel 1 and the focused saturation of Channel 3, it is also possibly the most versatile of the three Channels. It starts out with the almost-clean lower settings of the EDGE Mode and works its way up the gain scale with the mid to almost-high gain aggression of CRUNCH and tops out with the thick, liquid wall of gain available in the MARK I Mode. We suggest that you really spend some time with the GAIN control in each of these modes as they all contain sounds that will surprise you. For example, there are some great forward, skinny clean sounds in the low region of EDGE, some awesome Rock single note solo sounds in the high region of CRUNCH and some soulful soft-clip rhythm and surprisingly dynamic and howling Blues lead sounds in the low region of the MARK I Mode. This explorer-minded approach to these - and in fact all the Channels and Modes in the **MARK V** will reward you time and again. So let's get specific with each Mode and ways to use them.

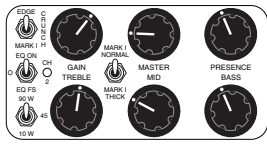

CHANNEL 2 VOICE SWITCH - MODE SPECIFIC:

MARK I: NORMAL / THICK

This two position switch re-voices the Treble frequencies to be either NORMAL (switch up) - higher and more sparkling or THICK (switch down) – lower and fatter in the upper midrange. This switch is active only in the MARK I Mode and does not affect EDGE or CRUNCH. Use NORMAL for lower gain chording and Blues work or anytime you want sweet top end and harmonic openness. Use THICK for added gain and girth to fill-out single note sounds and make high gain rhythm sounds grind harder. You can also think of NORMAL as being more “black face” era, and THICK voiced to more of a British amp vibe.



FRONT PANEL: MODES (Continued)

EDGE (Mode Select Switch Up):

EDGE is the lowest gain Mode in Channel 2. It starts out virtually clean and starts to clip gradually after 12:00 until it gets aggressive at around 2:30 on up to wide open. EDGE is also the most urgent and dynamic of the Modes in Channel 2. This is largely due to the stripped, tight, low-end character of this circuit that is achieved by voicing the bass frequencies much higher than that of its Channel 2 counterparts. With the low frequencies being centered up an octave (some even two) the mids and highs are allowed to race through the circuit unhampered creating a fast, articulate sound that retains the dynamic content and cuts through with brazen authority.

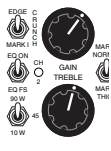

Because the low end in the EDGE Mode is tucked up and tighter, it is possible - and even recommended - to run the BASS control higher than you would in almost any of the other Modes (12:00 – 3:00). Also, because the mids and highs are so much more prominent in the mix, it is wise to use the TREBLE and PRESENCE control a little more sparingly than you might in CRUNCH and the MARK I Mode. You will find that EDGE is quite bright with most pickups and it may be necessary to set the TREBLE below 11:30 to get the sound to be warm and thick enough, even with the BASS set higher. The MID control passes a fair amount of upper frequencies as well, so it can be used to open up the sound and add cut in a different region. Try the MID low (9:00 – 9:30) and the PRESENCE higher (11:30 – 2:00) and the opposite – MID high (12:00 – 3:00) and PRESENCE low (10:00 – 2:30) to get a feel for this different way of voicing the top end.

The clip characteristic in the EDGE mode is bright and jagged as opposed to round and smooth, so if you are looking for more of a furry, purring clip it would be wise to look to CRUNCH or a low setting of the MARK I Mode.

If you are looking for an alternate clean sound to footswitch to, EDGE can provide a more aggressive clean voice that will have a high mid bump and a sense of urgency. Set the GAIN low (10:00 – 11:30), the TREBLE low (below 12:30), the MID low (8:00 – 9:30), the BASS control high (1:00 – 3:00) and adjust the PRESENCE to taste to bring in the top end you want.

CRUNCH (Mode Select Switch Center):

This mode is brand new and represents the “crossover mode of the crossover Channel”. It is more balanced, frequency-wise, than EDGE and it climbs just a bit higher on the gain scale. There is more low end fundamental voiced an octave lower and some warmer low harmonic air present here as compared to EDGE, but less than the MARK I Mode, so it falls right in the perfect spot between the two.

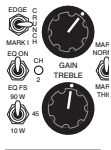

CRUNCH provides a sound that still has urgency and dynamics, yet is warm and rich and covers the valuable ground from the onset of clip up through grinding crunch rhythm. This makes CRUNCH one of the most versatile Modes in the entire amp and despite its name, this sound works equally well for both chording Rhythm and single note Lead work.

You will find that the TREBLE control can be used in the higher range without becoming too bright - as compared with the EDGE Mode, where higher TREBLE settings can be a bit much. This will add gain in the top end and you can reduce the PRESENCE if it gets too bright. Conversely, the BASS can be reduced in CRUNCH to get some increased tightness and yet the overall character remains warm with plenty of low end inherent in the basic character.

CRUNCH also works beautifully in tandem with the Channel POWER SELECT switch. Some amazing sounds arise out of the 45 and 10 watt Modes, where different amounts of power section clip can be blended in - allowing you to back the front end GAIN control down and achieve the perfect soulful blend of pre and power clip. Again, this applies to both chording and single note sounds.

Using CRUNCH for the almost-clean, onset-of-clip sounds requires a fairly low GAIN setting as it has quite a bump compared to EDGE. You will probably want to run the GAIN at 10:00 – 11:00, the TREBLE lower (11:30 – 1:00), the MID fairly scooped (8:30 – 11:00) and add BASS for the thump (11:00 – 1:00). Adjust the top end cut and openness with the PRESENCE, as it will not add additional gain to the mix.

FRONT PANEL: MODES (Continued)

MARK I (Mode Select Switch Down):

This is it! The sound that started it all and put MESA on the map when it burst on the scene back in 1970 aboard the little Boogie combo. This devastating little wolf-in-sheep's-clothing introduced the world to the first high gain preamp and ushered in the Modern Era of amplification. Before the MARK I, all amplifiers were the same in the sense that they were all about the same gain-wise. Amplifiers created before this belong to the Vintage Era and in a sense, the MARK I is really a pivotal moment that changed music for all time, or at the very least...guitar music.

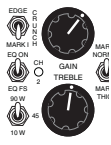

Randall Smith smashed the barrier when he built the first high gain cascading preamp and gave electric guitarists literally a hundred times more gain than they had ever experienced before. Suddenly a new solo voice came from the guitar when - for the first time - notes could have sax-like fluidity and finally... virtually unlimited sustain. And equally important this sustain was - for the first time - independent of volume! Now a player could get any sound, from pristine clean to a beautifully contained explosion of overdrive at any volume anywhere. Needless to say, the news spread quickly when guitarists the world over heard this sound on Carlos Santana's ABRAXAS album. Immediately a flood of orders for the little Boogie came pouring in to the little mountain shack in Lagunitas, CA. and soon most all of popular music had a Boogie somewhere in the mix.

Forty years later that sound is alive and well and has given birth to a whole family of circuits we still build today, including this Mode in the **MARK V** and the re-issue MARK I.

This circuit is extremely versatile and shines for both rhythm and single note soloing but these different applications require a different approach to settings. However, two things tend to remain a constant in regards to the Tone Controls, no matter what the application. First is that the TREBLE control is quite effective at adding gain to the signal so that higher settings (12:15 – 3:00) can be more useful than in the other Channels. This is related to the second trait of the MARK I circuit... that there is huge amount of Bass, in fact sub-low Bass, present in this mode. It's also a good idea to remember what we mentioned earlier in the HELPFUL HINTS section - as the GAIN goes up the BASS should come down. Many of the great sounds available in this mode will present themselves with a lower than normal setting on the BASS control and a higher than normal setting on the TREBLE. The Tone control string is highly interactive and this approach sends less signal to the BASS and MID control where an abundance of fat low-end lives.

This approach is especially true for higher gain single note sounds where you may want to run the TREBLE at around 2:30 and the Bass (and maybe the MID as well) at 9:30 or below. For lower to medium gain solo sounds you can run the TREBLE a little lower – (12:30-1:30) - and the BASS and MID up a bit (9:30 – 10:30) to add warmth and air.

When using the Graphic EQ (SLIDERS or PRESET) for high gain heavy sounds in the MARK I mode, it is important to keep the BASS control rather low. If you jack up the low-end with the EQ and there is already a fair amount of low-end dialed up on the rotary BASS control, you might overload your speakers and even perhaps damage them at high or extreme volume settings... not to mention it will sound flubby and swamped with lows.

FRONT PANEL: MODES (Continued)

CHANNEL 3:

Channel 3 is a tribute to the entire line of MARK series Channel Switching amplifiers and contains three circuits from the pinnacle of that architecture. The two most sought after of these, the MARK II-C+ and the MARK IV, provided both the starting points and ultimate reference for this collection of Modes. These two amplifiers share a long and prestigious list of credits and together are responsible for some of the most iconic high gain guitar sounds ever recorded. Channel 3 contains the Lead Channel of the II-C+ and two Modes from the MARK IV, LEAD and LEAD EXTREME. These are all faithful recreations that benefit from our 40 years of super-tuning high gain tube amps and all the trade tricks and hidden secrets we've learned along the way have been employed in creating these ultimate MARK sounds.

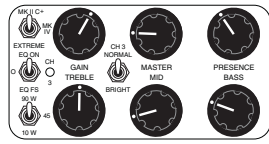

This is the highest gain of the three channels in the **MARK V** and would be thought of by many as the Lead Channel, however there are as many ways to apply these super-focused sounds as there are people who use them. The trademark mid-focus to the gain lends itself equally well to both chording rhythm and single note solo sounds because of its' articulate, tight-tracking response and lush harmonic layering. These circuits also provide amazing resolution across the gain scale with great threshold-of-clip, pushed clean sounds found at the low end of the GAIN control and searing, explosive lead sounds at the high end... with a whole range of urgent, tight crunch rhythm sounds in between. This fine resolution of gain and clear definition makes Channel 3 easily as versatile as the other Channels and you have hours of fun exploration ahead of you as you learn how best to utilize this powerful Channel for your needs.

CHANNEL 3 VOICE SWITCH - CHANNEL SPECIFIC:

NORMAL / BRIGHT

This two-position switch determines the amount of upper harmonics present in the sound of all 3 Modes in Channel 3. Some sounds bring forward the action of this switch more than others, depending on the amount of top end in the sound to begin with, but it adds or reduces brightness at its location in the signal path in all Modes of this Channel. For example; you will hear its action more in the MK II C+ Mode than you will in the MK IV (FAT) Mode - because the high frequencies are more rolled off and recessive in the MK IV Mode and therefore there are less of these frequencies present for the BRIGHT switch to bring forward.

In the BRIGHT position (switch down) the sound will be infused with an upper harmonic halo around the note(s). This added top end becomes more apparent as the GAIN is increased, especially in the MK II C+ and EXTREME Modes where the BRIGHT circuit has more highs to work with. The BRIGHT position is great for adding harmonic grind to high gain chording sounds in these two Modes. It lets these highs pass at a specific earlier stage in the preamp so that the PRESENCE and GRAPHIC EQ, can be used to blend and shape them down the line.

In the NORMAL position (switch up) this region of upper harmonics is rolled off, creating a darker, warmer blend that works well for single note soloing. The NORMAL position is great for adding a feeling of girth and fatness in low gain sounds and removes unwanted sizzle and buzz that can result from low output pickups in high gain settings.

FRONT PANEL: MODES (Continued)

MARK II-C+ (Mode Select Switch Up):

NOTE: The original MARK II-C+ amplifiers had power sections wired in TRIODE configuration. To hear the sound of the original II-C+, set the Rear Panel Channel 3 Power Switch (located below CH. 3 REVERB Control) to TRIODE. See IMPORTANT NOTE at the end of this section for further information.

This is a recreation of the much sought after sound of these two channel MARK series amps produced in the mid eighties that became the voice of choice for so many recording artists of the day. Today there is a hard-core cult following for these vintage II-C+'s and - when they can be found - they bring 3 - 4 times their original price. Many artists even now have standing orders with their techs to buy these amps wherever they are found, regardless of price. There will probably be those who tout the tone and authenticity of their prized vintage gems (yes, we are pleased and flattered) – and just like vintage guitars this will probably always be the case. However, rest assured...you now own a MARK II-C+ down to the last circuit detail and the tone is identical except for the Sylvania 415 power tubes, which are no longer available. During the R&D process we even found ways to mimic the important mid-punch character inherent in those tubes. And far better... you don't have to compromise your clean or lead sound because they share controls as they do in the original layout! You also get another sound to switch to that also has no shared controls or compromise! So, if you run into II-C+ snobs who brag about their amps or doubt the authenticity of your rendering, smile and feel a pang of pity for the price they probably paid and let them have their glory. After all, they need their pride because they don't have the other 8 amplifiers you have on board to express themselves with.



The II-C+ trademark sound is urgent and stripped but also has incredible focus despite its' precious multi-dimensional layers of upper harmonics. It works equally well for both aggressive high gain chording and blistering single note soloing in low or high regions of the GAIN control. When dialed in (GAIN 1:30 – 2:30, TREBLE 12:00 – 1:00, BASS 10:00 – 12:00, PRESENCE 9:00 – 11:30), it has a lead voice that is unrivaled in articulation, nuance and time domain accuracy in the high gain genre. These qualities are especially favored by those players whose technical ability demands instantaneous response and tight, detailed tracking of the pick attack. After the attack, a beautiful morphing of harmonics occurs and the notes segue through a whole range of dynamic and frequency changes that is a joy to experience. You will find yourself playing like never before and reaching newfound depths of expression.

For high gain rhythm work the II-C+ unleashed the other sound in Heavy Rock Crunch. More complex and harmonically layered than its' British fueled counterpart, the C+ comes on like a grinding wall of gain that is truly menacing. This aggression and sheer size is made even more impressive with the application of the on-board Graphic EQ. The shameless scooping of mids and rebellious boosting of both lows and highs simultaneously led to the iconic "V" curve becoming so popular in the eighties recordings, that it became synonymous with the II-C+ sound. This sound reached further notoriety and became referred to as Boogie Crunch and even the "California Sound".

Throughout the nineties our Dual Rectifier's sub-low enhanced grind and punishing blend of attack and harmonics became the pop-metal sound of the decade. However, there remained a strong cult following for the MARK Series/Graphic EQ crunch sound (re-introduced in the MARK IV) and this tighter, more articulate sound is now a classic and here to stay. In the current decade it has become the crunch of choice for high tempo aggressive Punk and Indie Rock chosen once again for its' ability to stay glued to the pick attack and track even at burning tempos.

There are no real danger zones or pitfalls with the C+ Mode other than the obvious ... turn the BASS control down slightly in proportion to your increase on the GAIN control. Don't try to run the GAIN maxed out with the TREBLE and/or PRESENCE way up as preamp tubes will most likely not handle this abuse and begin to show their individual degree of microphonicity.

FRONT PANEL: MODES (Continued)

Hints for the C+ Mode might include these:

Use the Graphic EQ - SLIDERS or PRESET - if you need extreme low end with high GAIN settings - this comes later in the circuit and will have less tendency to get loose and flubby than that of the rotary BASS control.

Work with the GAIN, TREBLE and PRESENCE in finite increments when searching for your ideal lead voice as these interact greatly and have a big effect on pick attack sensitivity and focus. The PRESENCE compresses things in its lower regions creating a more voice-like character and opens up the upper harmonic region in higher settings creating a more cutting, blade-like attack.

For lead sounds - Roll in the amount of BASS you want after fine-tuning the attack signature with the GAIN, TREBLE and PRESENCE. Fill things in just enough but don't create flub. The MARK Series BASS control brings in beautiful rich low end but can also overtake the balance set by the other controls quickly and degrade the attack.

Don't overlook this Mode for lower gain sounds! Because of the harmonic content and instant attack properties, the C+ Mode excels at low gain Blues sounds – both rhythm and single note – and even can produce some threshold of clip, almost clean sounds. It's open and dynamic and responds great to plucking techniques as well. Traditionalists have even commented on how well the old "guitar volume knob" or "old- school channel switching" approach works with this sound. Set low enough, the C+ Mode works great just backing off for clean and cranking up for lead on the guitars' Volume pot. When the GAIN is this low you can dial in more BASS on the rotary control to add warmth and three-dimensionality.

IMPORTANT NOTE! Be sure to experiment with the TRIODE/PENTODE switch located on the Rear Panel under the Channel 3 REVERB Control. This switch re-wires the power tube configuration to produce a radical sound and feel difference. We have found many players like it only one way – citing that it makes or breaks the vibe for them or that they can't play as well when it's not set to their favorite way. We feel it is a powerful stylistic parameter and should be explored fully for its usefulness to your sound.

TRIODE softens the midrange attack and accentuates the upper harmonic region creating a silky, more liquid feel and lowers overall output power. PENTODE accentuates midrange punch and lowers the upper harmonic region for a bolder, tighter attack – especially in the low end – and increases output power and headroom. ALL original II-C+ were hardwired to TRIODE.

This is an addicting mode to play and one of – if not the most expressive - of the 9 Modes in your **MARK V**. Do yourself a favor and spend some quality time exploring how the controls interact... once you dial it in for your individual style... magic will happen.

FRONT PANEL: MODES (Continued)

MARK IV (Mode Select Switch Center):

This Mode revitalizes the most recent MARK Series amplifier and brings its iconic sound forward for this - and future generations to enjoy with a whole new set of features and a new plateau of versatility. The **MARK V's** predecessor, the MARK IV, was built continually for eighteen years – all that time winning new fans around the globe, proving that the MARK Series sound can't be outdated by changing styles, trends or advances in technology... it's a classic and here to stay.

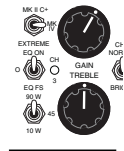

In comparison to the MARK II-C+ Mode, the MARK IV mode is infused with more low mid and has an attack characteristic that is wider and less pointed in the upper midrange. The bottom end goes down lower and has more gain as well, giving the sound thickness and girth that produces huge, ominous crunch chords and smooth vocal single note sounds. These circuit differences create a different feel as well, and the MARK IV Mode feels creamier and gives the impression of less resistance on the strings - making it easier to play for many guitarists. The slightly less-instantaneous attack created by the addition of low end makes the IV Mode feel a little slower and less like your picking technique is "under the microscope" which can be either freedom or lack of definition - depending on your point of view and stylistic needs.

For lower gain sounds the MARK IV Mode will have more air and three-dimensionality than its C+ counterpart. Some nice purring threshold-of-clip sounds can be found with the GAIN set very low (9:00 – 10:00) and the TREBLE around 12:30. With the GAIN this low you can dial in quite a bit of BASS (11:00 – 1:30) before things get too tubby, letting you really move some air. Here is also a great place to experiment with both the TRIODE/PENTODE switch positions and/or the POWER MODES. The 90 watt setting in combination with PENTODE will produce a bold, punchy sound that will let you jab with authority. The 45 and 10 watt settings in combination with TRIODE will give you a more laid back attack characteristic and a more harmonically complex voice filled with nuance.

High gain sounds in the IV Mode are fat! The lower bass frequencies combined with the added gain in the low mids makes for the biggest crunch chording sounds in the entire amp. In these applications you will have to watch the setting of the BASS control more carefully as the lower frequency bottom end can get bloated much faster. If you are looking for huge bottom end with high gain settings, it is wise to turn to the Graphic EQ SLIDERS or PRESET to achieve this. The BASS control dumps too much sub-low into the signal path at a point earlier in the preamp. This gets amplified over and over until it turns to flub where as the Graphic EQ comes at the end of the signal chain and adds low end to the "finished preamp sound".

The Channel-global NORMAL/BRIGHT switch is very effective at bringing forward the upper region of harmonics – especially when using the MARK IV Mode for high gain chording and even single note sounds. When adding this upper-stratosphere layer of tone by engaging the BRIGHT position, it may be necessary to reduce the PRESENCE control (which contains a narrower, adjustable band of these highs) in order to arrive at the sound that is right for your application. Some people are very sensitive to these upper highs – hearing them as edgy, buzzy and unpleasant. For those players the NORMAL position was provided to notch them out almost completely. We feel they are an important part of the spectrum as they give the sound spacial width, openness and the beautiful layer of stacked harmonics we work so hard to achieve. However, they must be blended in as an integral part of the sound.

This can be achieved in a number of ways once you've decided to include this region of the spectrum with the BRIGHT switch such as the rotary Tone Controls, the Graphic EQ, The TRIODE/PENTODE switch, the speaker cabinet and finally... a big component people tend not to look at, their guitar and its' pickups. Even their own individual picking and fingering technique and the gauge of strings they use – all of these factors will affect the type and amount of high harmonics that can be introduced and still sound balanced - one integrated tone – rather than shrill or even annoying. This is a good time to make one point about the MARK IV.

Pickups are a huge factor and ingredient in the overall character of your tone. Many players stick with one instrument and if they are having trouble dialing in a sound on their amp they overlook the fact that the sound begins – and is largely defined by – what is sent to the amp from their instrument.

High gain sounds are especially sensitive to the output and voicing of pickups and even more so, to the amount of high end that is

FRONT PANEL: MODES (Continued)

emphasized. In our experience weaker more vintage style pickups accentuate the upper harmonic region and are wonderful for shimmering, bell-like harmonics and clarity in low to medium gain applications. When you are looking for higher gain performance, these types of pickups will present some challenges as all those upper harmonics can get buzzy and thin sounding as the gain increases. You will likely find it necessary to roll the TREBLE and PRESENCE back substantially when searching for a high gain sound that is focused and pure with these pickups.

If high gain is your bag you have probably already come to the conclusion that you need a fairly high output pickup – at least in the bridge position – to achieve the tight focus needed to produce cohesive high gain sounds. If not, may we suggest that you try several different higher output pickups – which tend to put an emphasis on the midrange and higher midrange as opposed to the top end. This voicing difference will produce tighter low end for crunch chords and a more voice-like single note sound.

Some of the higher output pickups will have taps - or can be tapped - at a halfway point in the winding, giving you the best of both worlds – a weaker output/brighter tap - and the full winding - high output/punchier mid setting. This is usually controlled via a mini toggle or a pull pot, but can also be hard wired to a specific position on a standard 5 way or toggle. This is a great way to have the most versatility possible and keep the high harmonic content and openness for your low to mid gain applications and then, be able to switch your guitar - along with the Channels of the **MARK V** - to a high output/high gain machine capable of tight, ferocious heavy sounds.

HIDDEN TREASURE: The amp you are playing through was designed to be a tool that can serve up virtually any style of guitar sound you want and set you free to play your best. It also has another hidden attribute that it may take some time – even years - to appreciate and assimilate. It has the (somewhat hidden) potential to become one of your best teachers as well. Sounds weird, even hokey? Maybe... but we could never count the times customers, both new and long-time Boogiephiles, write in or call and tell us that their playing and technique has improved greatly since acquiring a MARK Series amplifier. They comment that the articulate nature of the attack and the incredible detail and touch-sensitivity force them to pay more attention to their technique and even phrasing because everything is so accurate. They also comment on the feeling that the amplifier is giving them back as much as they are putting into it emotionally! I (the author) am convinced of these benefits, and I know in my heart playing exclusively MARK Series amps since my early childhood radically shaped my development as a player and improved the quality and cohesiveness of the sound coming from my hands. Call me jaded, clueless or just plain spoiled, but I would much rather stay home and play my acoustic guitar than to go to a gig without a MARK Series amp. We sincerely hope you find this hidden subtle layer of help valuable over time - as so many of our worldwide family have – and wish that it takes your playing to places you may never have imagined.

IMPORTANT NOTE! *Again, be sure to experiment with the TRIODE/PENTODE switch located on the Rear Panel under the Channel 3 REVERB Control. This switch re-wires the power tube configuration to produce a radical sound and feel difference. We have found many players like it only one way – citing that it makes or breaks the vibe for them or that they can't play as well when it's not set to their favorite way. We feel it is a powerful stylistic parameter and should be explored fully for its usefulness to your sound.*

TRIODE softens the midrange attack and accentuates the upper harmonic region creating a silky, more liquid feel and lowers overall output power. PENTODE accentuates midrange punch and lowers the upper harmonic region for a bolder, tighter attack – especially in the low end – and increases output power and headroom.

FRONT PANEL: MODES (Continued)

EXTREME (Mode Select Switch Down):

The last Mode in Channel 3 is named appropriately and is all about more! More gain, more attack, more punishing mids, more tight, huge lows and as you have probably discovered by now, more output volume. EXTREME traces its' lineage back to a feature on the MARK IV that resided on the Channel 3 (LEAD) PRESENCE control of that amp. A pull-pot fitted there allowed removal of negative feedback from the power section and unleashed the pent-up fury of the Simul-Class™ output.



This feature (now a Mode) allows the power section Presence circuit to respond to all frequencies more equally – instead of a chosen adjustable set of high frequencies - and removes an element of “control” and inherent compression in the power amp. This “wider EQ” curve in the “rear-end” creates a rebellious, unleashed and extremely “open” personality that can't be duplicated with “front end” preamp circuitry. When this radically aggressive power personality is combined with the high gain wall of layered harmonics present in the MARK IV Mode a sound of truly stunning proportions is created.

EXTREME in the *MARK V* benefits from all the years we've spent creating these and other high gain modes and we've taken liberties with this tribute where there was TONE to be gained. Top end has been warmed, low end has been tightened and the feel has improved, making EXTREME in the V easier to play and even more expressive than its' predecessor. There may be some IV owner's that prefer the slightly more notched sound of their amps, but the attack, body, girth and versatility of the V's EXTREME Mode will allow you to wield this power in more places for more styles – even venturing into some lower gain applications – that the IV dare not go.

Many devotees of Hard Core love the way the EXTREME Mode can handle very high settings of the GAIN control and still retain the attack and tightness of high gain chording. It is not even necessary to run the TREBLE high to achieve this tightness and settings in the 12:00 – 1:00 range are common. Remember that for very high gain chording it is better to set the BASS control lower (10:00 – 11:00) and look for additional low end using the Graphic EQ as bottom end introduced late in the signal chain will stay tighter longer than its' early preamp counterpart.

As mentioned above, some urgent, packing-an-attitude lower gain sounds are possible when EXTREME is used with lower settings of the GAIN control. For these types of sounds you can increase the BASS control (11:30 – 1:30) to add three-dimensional warmth to the sound since there is less gain dialed up and less chance of causing unwanted flub.

There will seem a slight decrease in the power of the rotary PRESENCE control in EXTREME as negative feedback has been radically reduced in a broad range of frequencies, including those chosen for the PRESENCE circuit, which means there is less for the narrow band affected by the PRESENCE to work on. This is not an issue as there are plenty of highs available on the TREBLE control and in the top bands of the Graphic EQ or the PRESET to make the sound as bright as you need it.

Not to seem redundant, but do experiment with the TRIODE/PENTODE switch located on the Rear Panel (see previous MARK IV or II-C+ section) as the setting of this power section tuning feature makes a huge difference in both sound and feel.

For more vintage sounds in EXTREME with lower gain settings, try the TRIODE setting for a more bouncy, sweet and harmonically rich voice that has a fair amount of old school sag to the power.

For authority, punch and tight-tracking low end, try PENTODE when using EXTREME with very high GAIN settings. This will produce a more immediate attack response and deliver the most power and headroom to handle the huge lows associated with these styles. For these settings and styles you don't want any “vintage sag” slowing down your response and loosening up your low end and PENTODE will ensure that the power stays stiff and instantaneous.

EXTREME is the most radical and over the top sound in the *MARK V*. Just when you thought you had heard it all in the MARK IV Mode, EXTREME comes up to challenge all you thought you knew about in-your-face, aggressive sounds. Enjoy... but employ it with a dose of mercy for the poor souls in front of your cabs or close up in the audience as it is a truly punishing sound.

FRONT PANEL: EQUALIZER

THE EQUALIZER SECTION:

All MARK Series amps going all the way back to the MARK I - have included a powerful shaping tool that was in a groundbreaking feature back then - and continues to be one of the trademark components of the MARK Series sound... the 5 Band Graphic EQ. Many of the MARK Series sounds that have become classics were achieved by applying the Graphic EQ and radically altering the somewhat mid-pronounced voice of the MARK sound in favor of a more "scooped" midrange. The most popular of these altered sounds is the dropped-mid "V" curve that makes everything sound gigantic as lows and highs are boosted alongside these radically scooped mids. Because this sound shows up time and again on customers' amps we have included yet another way to utilize this classic sound.

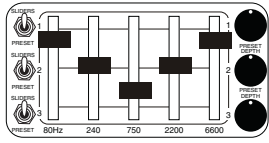

The *MARK V* takes this scooped-mid concept to a new place with the inclusion of Channel Specific rotary PRESET controls that can be assigned to any or all the Channels. Looking at the EQ Section you will see that the trademark Boogie 5 Band is joined on either side by a stacked row of controls. On the left you have a bank of mini toggles that repeat for each Channel and give you a choice of applying the SLIDERS or - for the first time - a very handy rotary control called PRESET which resides in the bank of knobs on the right side of the SLIDERS that allows you to dial in a desired blend of the mid-scooped "V" curve.

This assignable choice increases the power of the EQ section many times over and enables you to use the SLIDERS for specific tweaking of trouble frequencies for different venues or recording or to craft EQ curves that are uniquely different from the PRESET curve where mids are cut and lows and highs are boosted.

In each Channel you will find the three-position EQ CONTROL switch located in the center of the bank of switches just below the MODE SELECT switch. Here you either BYPASS the EQ Section all together - or decide how you would like to utilize it in a given Channel. The center position is EQ OFF (toggle middle) and this bypasses the EQ altogether. Set here the SLIDERS and PRESET knobs will have no effect on the signal.

"EQ ON" (toggle up) engages the EQ and applies either the SLIDERS or the PRESET depending on the selection of the SLIDER/PRESET switch on the left side of the EQ Section (SLIDERS = toggle up, PRESET = toggle down). In this position the EQ will remain on all the time in that Channel (regardless of any action taken on the FOOTSWITCH).

"EQ FS" (EQ FOOTSWITCH - toggle down) allows you to control the status of the Equalizer via the EQ Button on the *MARK V* FOOTSWITCH. In this position the EQ will only be in the signal path when you engage it from the FOOTSWITCH.

The center EQ LED light (far right of Front Panel above the POWER and STANDBY) will come on in tandem with the Equalizer when it is triggered by any of these means. This allows you to see from a distance if the EQ is engaged or bypassed.

The EQ is a powerful shaping tool and like any powerful tool should be used with care. Radical boosting of certain frequencies - especially very low and very high frequencies can put a strain on the tubes, speakers and your ears - so we suggest that you apply the EQ with taste and musicality in mind. You can also use up power and headroom more quickly by applying unreasonable amounts of low end with the EQ.

Because this EQ is capable of such extreme notching and boosting, when you turn it off and listen to the un-EQ'd sounds they will likely sound flat and honky to you. This is normal and to be expected... you have a good case of "EQ hangover". Like any over-indulgence you need to give your body - in this case your ears - time to recover. Waiting a few minutes will help your ears return to "normal" and the unaltered sounds will sound much more right again. May we suggest beginning any EQ application by first listening to the EQ BYPASSED version of the sound and then toggle on the EQ'd version to see how much EQ you are adding. It's very easy to "Over EQ" things with a powerful tool like the on-board EQ and blow holes in your sound or create an unbalanced curve that sticks out in unpleasant ways. In most musical scenarios the guitar still has to fit in a mix and not eat it for lunch. Again, use the EQ to subtly

FRONT PANEL: (Continued)

enhance the great sounds you have crafted with the Modes and other controls and you will always have amazing Tone.

NOTE: Some of the Modes work better than others with the EQ and respond better to the radical shaping power with a more harmonious demeanor. Generally speaking, the Modes that have less low end tend to work better and these are usually the ones that have created classic sounds with the EQ in place. The CLEAN and TWEED Modes in Channel 1, the EDGE and CRUNCH Modes in Channel 2 and all the Modes in Channel 3 (with the MK II C+ being the most friendly) tend to be the greatest candidates for positive EQ reinforcement.

CAUTION: The FAT Mode in Channel 1 and the MARK I Mode in Channel 2 have a huge amount of low end present in their personality already and therefore require a much more subtle and “bass conscious” approach to shaping with the EQ Section. Extreme boosting of the 80Hz and 240 Hz SLIDERS and very high settings of the PRESET control (above 1:30) should be avoided. These regions will introduce extreme amounts of low end to an already bass-heavy sound, which will produce huge flubbiness and swamp the mix and even cause possible damage to your speakers. Use the EQ with care in these two Modes.

POWER SELECT:

The **MARK V** offers three Modes of power (wattage) operation and these may be selected independently in each Channel. These choices are much more than simple wattage ratings created by a “standby” mode where some of the tubes are put in an idle state. In addition to changing the overall wattage rating, each of the power Modes re-configure the wiring style and change the operating class as these three Modes are selected.

A simple mini toggle located at the bottom of the stacked bank of switches controls each Channel's power and allows you to tailor the power output and style to best match the preamp sound you are dedicating a Channel to for your footswitchable needs. Three individual patents for the output section alone - two granted and one pending - reveal the incredible technology that your **MARK V** puts to use in creating the ultimate Tone – a magical blend of preamp and power output. No other amplifier employs such extensive power switchability and allows greater flexibility in the output stage. Whether or not you are an aficionado of output tube configurations, you will surely love the Tone and versatility of the **MARK V's** Simul-Class™ Power featuring Multi-Watt™ and Duo-Class™.

90 WATT (SIMUL-CLASS™ : CLASS AB + CLASS A, PUSH-PULL):

The 90 W position (toggle up) is our patented Simul-Class™ scheme and it delivers the most power with 90 watts of clean, sweet and yet bold power and headroom. In this position all four output tubes are on-line and two different classes of operation are being run simultaneously to create the most musical “hundred watt” output stage in the business. The outside pair (second from far left and the far right) are wired to Class AB and are running cooler - while at the same time creating the bulk of the horsepower. This modern way of running tubes is more efficient and produces the greatest power with the least heat.

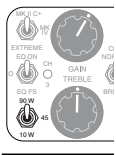

The inside pair of tubes run in “extended Class A” with their reduced bias and are “more on” all the time, whether there is signal present or they are at rest (when you aren’t playing). This wiring and bias style puts out less power and creates more heat, but in trade for the lack of efficiency, it features a much smoother clip characteristic and a smoother, warmer sound... especially at the onset of clip where the harsher transients can become unpleasant in a Class AB output section. Simul-Class™ takes care of all that and smooths out the rough edges and re-voices the highs - leaving you with a sweet musical clip in the transition zone and yet plenty of power and headroom. The 90 W (Simul-Class™) position is the way to go for most live performance situations where you need headroom for clean chording and tight articulate low end for crunch rhythm along with a sweet, vocal voice with authority for soloing.

FRONT PANEL: *(Continued)*

45 WATT (EXTENDED CLASS A, PUSH-PULL):

In this setting only the middle pair of 6L6s are on, and it's these that run in the extended Class A with their bias reduced. Thus, they run a little hotter but also smoother, especially across the threshold into clip without sounding harsh.

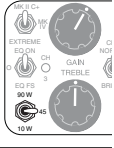

This essentially half-power position is great for pushed rhythm and threshold-of-clip sounds where you want a smooth break-up that is devoid of harshness and a slightly higher region of sparkling top end. It also excels at Blues, Roots and Classic Rock single note solo sounds, where you don't want to saturate the preamp too much in favor of adding some authentic power clip to the character. At gig volumes the 45 watt setting will be well into the power band ensuring that you are playing it old school when it comes to your overdrive.

RECTIFIER NOTE: In Channels 1 and 2, the 45 Watt mode includes the ability to select the type of high-voltage Rectifier best suited for your chosen musical style. (Since the Mark IIC+ and the Mark IV never used a tube rectifier, the switch location for Channel 3 is used for selecting Pentode or Triode, which allows you to achieve the exact performance of the originals – The Mark IIC+ was wired Triode, the Mark IV allowed you to choose via a Triode or Pentode switch.) In 90 watts, silicon diodes are automatically selected to deliver the necessary power while the 10 watt mode auto-tracks to the 5U4 tube for lowered voltage and traditional vintage performance.

As mentioned, different musical styles will benefit from the different characteristics of silicon diodes versus vacuum tube rectifiers.

DIODES deliver the maximum headroom and punch, tracking tighter, especially in the bass region. Clean sounds, crunch sounds and lead sounds will all be more explosive and focused and deliver the greatest articulation.

TUBE slows things down, reduces headroom, smooths things out and scoops upper midrange along with producing a more elastic, bouncy feel on the strings. Tube rectification is great for threshold of distortion sounds on rhythm parts and vintage style single note soloing. TUBE also re-voices the top end raising it up an octave and making it a little recessive at the same time.

10 WATT (CLASS A, SINGLE-ENDED):

This position features not only a low power version of CLASS A power, but it takes the vintage mojo even further and switches the wiring configuration to Single-Ended! In the world of output stage wiring, Single-Ended is the holy grail of circuits. It is the sweetest, smoothest power style you can achieve and though the power available in this type of circuit is very limited, the sound is truly golden.

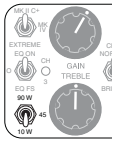

Single-ended wiring emphasizes the second harmonic-- the one that's cancelled out by push-pull. Because the second harmonic is one octave above the original fundamental note, it's very consonant. It actually sweetens the note, adding a halo of richness that is eliminated by the more modern and powerful push-pull circuits. As amplifiers were originally developed, push-pull was seen as a great improvement: more power and less distortion. But those early amps were designed for theater sound, for the then-new "talkies", not for musical purposes where those harmonics can become part of a magic expressive tonality. It's interesting that some of the most expensive and sought-after "high-end" stereo power amps today are single-ended Class A using the same 300B Triode tube as those old movie theater amplifiers. And they're revered for their "musicality"!

For 10 WATT operation the two 6L6s next to the 5U4 supply the single-ended Class A audio power as they are wired in parallel, not push-pull. Meanwhile the other two function as a "current sink" to enable the push-pull output transformer to continue to operate properly in a single-ended configuration. This patented technique overcomes the obstacle that a single-ended output transformer requires a "gapped core" to prevent DC saturation, while such a core would seriously degrade push-pull operation where the balanced and opposing magnetic fields prevent saturation.

Use this setting to practice with at home as it feels amazing on the strings and sounds rich, full and gorgeous for both clean chording and overdrive solo sounds. It begs to be pushed into clip with lower preamp gain settings to create dynamic and super expressive

power tube overdrive. For recording Blues and Classic Rock styles it is hard to beat the raw, urgent clip of the 10 Watt setting when it's combined with all Modes in Channel 1 and the lower half of the GAIN control settings (10:00 – 1:00) in all of Channel 2.

The Single-Ended output also holds up surprisingly well to the higher gain sounds in Channels 2 and 3. It allows you to achieve ridiculous amounts of saturation at very low volume levels and still retain focus and definition. The low-end tightness will eventually start to soften a bit and feel slower – especially if you are dumping huge amounts of bottom into the mix with the Graphic EQ - but there is plenty of room to experiment volume-wise before this becomes an issue.

Make sure you check out the TWEED Mode in Channel 1 maxed (GAIN all the way up, TREBLE 2:00, BASS 8:30 – 10:00, PRESENCE 10:00 – 12:00) in combination with the 10 Watt setting for some outrageous clipped old-school rhythm sounds. This is one of the coolest urgent, raw, Rock sounds that feels just juicy enough - yet still has dynamic punch. In fact, this sound works great for those who don't like footswitching and don't use tons of gain for their solo sounds... simply roll back on the guitar's volume knob for chording and crank it up for a great vintage style lead sound. TWEED in 10 Watt is a whole amp in itself!

NOTE: *The 10 Watt Mode is not really intended as a viable part of the Footswitching matrix of the **MARK V** due to its limited volume capabilities. While it is plenty loud to play with others, there are huge internal voltage changes that occur when you switch to - and back out of - the 10 Watt setting from the other two power settings (90W & 45W).*

These voltage changes across the power tubes and related power supply create noise (pop) during the instant that the voltage is changing and though there is an entire circuit that mutes many places in the signal path, this pop is still audible. If you insist on switching between some Channels that are in 90 Watt or 45 Watt and others that are in the 10 Watt Single-Ended mode, you will have to overlook the "pop" in favor of achieving the exact sound you need. This is unavoidable, normal and will in no way hurt your amplifier.

Regardless of how you assign the power throughout the Channels to achieve your favorite sounds, the **MARK V** offers performance, awe-inspiring power-matching for your preamp sounds and a new plateau of versatility previously unavailable in one amplifier. Now you can smile when you see guys dragging around a fleet of "boutique" amps of different power ratings to get their groove on... the **MARK V** gives you all that and much more with one trip to the car!

Now let's take a look at the individual controls and learn how they interact to create the sounds you want to hear.

FRONT PANEL: THE CONTROLS

GAIN: This is, by far, the most powerful control in the *MARK V* and its setting determines the style and personality of all three Modes in each of the Channels. It meters the gain in different tube stages depending on the Channel and Mode called up – and it sets Input Stage headroom - which determines whether the sound will be clean or overdriven. It also acts as a subtle Tone control as the tube stages' gain is increased and decreased and imparts its own “color” on the sound.

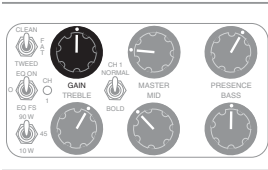

In all the Channels, there are three regions of the GAIN control – a low gain zone between 9:00 - 11:30, a warmer, more saturated zone from 12:00 - 2:00 and a higher gain zone from 2:30 – 5:30. Each of these zones can be used for many different applications and all can be used for both chording and single note solo work. As the GAIN control is swept throughout its range it imparts different textures and tonal characteristics.

Generally speaking, the lower end of the control (9:30 – 11:30) in all Channels and Modes produces a brighter, more open character that has more dynamic content available. This region is great for clean, sparkling chording in Channel 1, where the maximum headroom is available and the top end harmonics are bubbly and the attack is lightning fast. The Modes in Channel 2 are tuned to deliver amazing threshold sounds in this zone where the gain is warm and furry, but there is still plenty of the guitar's personality intact. This zone is great for all the Channel 2 sounds when used for clipped chording as there is plenty of dynamics intact that have not yet been compressed by too much saturation. Channel 3 also responds well in this lower region and similar chording and solo sounds await you here. You will be pleasantly surprised that the same Modes that can sound so vintage-approved and agile when set low can be the same ferocious high gain Modes when things get pushed.

The middle region of the GAIN control (12:00 – 2:00) is where the most balanced sounds live and you will find this region delivers warm, full sound, detailed attack and good dynamics and the Tone controls still have a powerful effect on the signal. The Channel 1 CLEAN and FAT Modes deliver great chording response and sound richer and have more body here. Depending on pickup style and strength you will have to watch for clipping as you are nearing the crossover point - gain-wise. Some of Channel 2's best sounds are to be found here as things start smearing nicely as they start getting into delicious tube overdrive. The Channel 3 Modes offer their greatest flexibility, focus and detail in this middle zone. As these sounds are all higher gain than their Channel 1 and 2 counterparts, the best dynamic response and attack characteristics are in this window. As you approach 2:00 there will be plenty of saturation to keep chords grinding and single notes hanging – but not too much to start compressing the life out of the sound. If you aren't getting great results in this region for your gain sounds in Channel 2 and 3, you may want to look at trying some pickups with a bit hotter output.

The highest region of the GAIN (2:30 – 5:30) is all about saturation. Up here the signal gets much fatter in the low end and the top end begins to recede to create a round, compressed sound. Dynamics become slower with lower peaks and a more legato, creamier feel is produced. In Channel 1 the high end of the GAIN control produces some great “clipped clean” sounds as the Input stage gives it up and starts to saturate. These sounds are further enhanced by the 45 and 10 Watt Power Modes and the VARIAC POWER setting on the Front Panel POWER switch. Channel 2 gets truly wild at the top end of the GAIN control and all three Modes unveil their true potential as lead Modes. There is ample gain up here to rip into any style you wish – with the MARK I Mode pumping out ridiculously high volumes of thick creamy overdrive for soloing. Channel 3 is absolutely over the top when the GAIN is run this high. The more midrange-prominent character of these Modes allows you to still have good articulation here even with amounts of saturation that would turn most circuits to useless mush. The focus, articulation and tightly-glued gain that sticks to the notes and tracks flawlessly is a sound that is pure Boogie... and the only amp that can achieve this is the *MARK V* (and of course its earlier MESA predecessors). Up here you will notice the Tone controls have a diminished effect on the sound as the notes are so saturated and their character has been pre-determined by the way each Mode is voiced and how it reacts to this level of gain.

FRONT PANEL: THE CONTROLS (Continued)

MASTER: This control determines the overall output level of each Channel and is located at the very end of the preamp. By using it in combination with the GAIN control, any amount of preamp signal strength – gain – (within a Modes' parameters) can be achieved at any playing volume. Once you have dedicated the Channels to their respective sounds with the Modes and Controls, you can then balance the volume levels of the Channels using the MASTER controls.

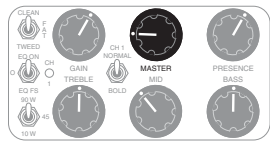

For you purists... when the EFFECTS LOOP is set to the HARD BYPASS (toggle down) setting on the Rear Panel, the MASTER control becomes the final volume control (because the OUTPUT level control is part of the EFFECTS LOOP circuitry). To raise or lower the playing level of the entire amplifier, you must adjust all three MASTER controls in the three Channels.

The MASTER also functions as an EFFECTS RETURN control for the EFFECTS LOOP when the LOOP is engaged (LOOP ACTIVE, toggle up). After you have set the Input level signal strength of your effects using the *MARK V*'s EFX SEND LEVEL control, flip the LOOP to HARD BYPASS and check that you still have unity gain (the sound doesn't drop or increase in volume) and if not adjust the MASTER control(s) until the volume stays roughly the same as you toggle the EFFECTS LOOP in and out of the signal path.

For general applications and to get the best performance out of all the Modes we recommend MASTER settings in the 9:00 – 12:00 range with most people settling in around 10:30 for average playing volumes. When the LOOP is BYPASSED you may need higher settings for larger venues, and this is fine.

Some purists like to run the MASTER all the way up and raise the GAIN until they reach their desired sound – thinking that this achieves the purest sound. In theory, they believe this resembles removing the control altogether from the signal path, and in a way it does. However most all the “vintage non-master” amplifiers they are seeking to emulate have discrete resistors in that place in the circuit anyway to adjust or “tune” the output of the preamp to the power section sensitivity.

The MASTER is nothing more than a variable resistor that offers an infinite range of settings possibilities and makes the amplifier many times more versatile with no sonic penalty. If you prescribe to this old school approach, then by all means, use the *MARK V* this way... it won't hurt the amplifier. However you will be severely limiting the potential sounds you can achieve by removing the limitless great sounding combinations of GAIN and MASTER settings.

PRESENCE: This control adjusts high frequencies - above those of the TREBLE - and is located in the power section, farther downstream in the signal path, and not in the preamp. The PRESENCE adjusts a specific zone of frequencies in the negative feedback circuit of the power section that best suit the needs of each individual Mode. The *MARK V* incorporates substantial circuitry to achieve the complex switching of parts needed to voice each Mode correctly and ensure an adjustable range on the PRESENCE that is sound-style appropriate as well as musically usable.

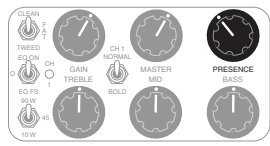

You can think of the PRESENCE as a control that allows you to either clamp the power amp down, compressing it and darkening things - or open it up and let the full spectrum of upper harmonics come blazing through. It also has a great deal to do with how dynamic the signal is and how a sound will cut through the mix in an ensemble environment.

At low settings (7:30 – 10:30) the sound will be warm and round with a more compressed feel and dynamic fluctuation will be limited. As the PRESENCE is increased (11:00 – 2:30), the top end starts to become more dominant and that compression gives way to “cut” and dynamic peaks jump out with startling speed and accuracy. At the top end of the control (2:30 – 5:30), a super aggressive blend of upper harmonics dominate the sound and this region can be somewhat dangerous if it's not applied in small measures. Higher notes will slice and dice even the bravest set of ears and we suggest using this region mostly in the studio for recording heavy crunch rhythm parts and even then – mostly on parts that feature the lower strings. This region – especially when coupled with the inherent curve of many of the microphones typically used in P.A. (sound reinforcement) applications can be truly punishing.

FRONT PANEL: THE CONTROLS (Continued)

We suggest using the lower to middle range of the PRESENCE (9:00 – 12:30) for the best (most balanced) sound in all of the Modes and venturing outside this only for specific applications – perhaps where you need more of an aggressive top-end point or a darker, more compressed and wider sound.

Clean sounds in Channel 1 can generally benefit from a bit higher settings (10:30 – 12:30) than sounds in this – or any Channel - that has overdrive involved in its makeup. Once saturation begins the frequencies carried in the PRESENCE control can make things edgy or brittle... even buzzy, real fast if you aren't careful. Overdriven chording sounds can tolerate higher settings (10:30 – 12:30) better than can single note sounds, which usually want to roam the zone below 11:00 to stay round, focused and vocal.

NOTE: The EXTREME Mode in Channel 3 radically re-voices the negative feedback in the power section - among its many changes - and inherently contains much more of this upper harmonic region than any of the other Modes. This increase in top-end cut and aggression renders the PRESENCE control somewhat less active than in the other Modes because there is so much bite there already in the EXTREME Modes' character.

NOTE: High settings of the PRESENCE (2:30 – 5:30) can put extra stress on even borderline microphonic preamp tubes (ones that are susceptible to high pitched ringing and noise) and cause them to begin ringing or show other signs of instability. Many tests were run on the set of tubes that shipped in your **MARK V** to ensure they were stable at the time of construction. However, tubes are not perfect devices – much like light bulbs – and can change over time and become more microphonic. Luckily you can remedy most tube problems with a simple tube swap. Avoid these settings (especially in Combo amplifiers – where the added sympathetic and vibrational forces put even more stress on the tubes) to ensure trouble free performance.

TREBLE:

If the VOLUME is the most powerful control in the **MARK V**, the TREBLE comes in a close second. The TREBLE is responsible for shaping the character of the entire amp. It can overpower the rest of the Tone controls easily and therefore its setting is crucial to a rich and balanced sound in all three Modes. In fact, the TREBLE feeds the signal to the MID and BASS controls and acts like a valve for their signal strength.

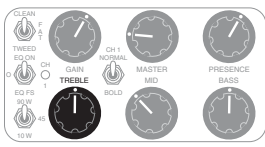

When the TREBLE is set in its higher regions (2:00 – 5:30) it is sending a smaller signal to those controls and they will be less active and the dominant character will be one of very bright, TREBLE-heavy frequencies. Conversely, a very low setting on the TREBLE will produce sounds that are perhaps a little

BASS heavy and overly dark as a very large amount of signal is shoved toward the MID and BASS controls. So you can see that setting the TREBLE with care and taste in mind is critical for the Tone control string to work in harmony.

In all the Channels and their Modes the middle region of the TREBLE delivers the best balance and creates sounds that are plenty bright enough but still rich and warm. We suggest that you start with the TREBLE at 12:00 and adjust up or down slightly until the desired blend is achieved. Remember that you can use the PRESENCE to add additional (and slightly higher) top end with no penalty in regards to the effectiveness of the other Tone controls as the PRESENCE is works in a part of the circuit that is much farther down the line in the signal path.

NOTE: One of the times you may want to throw caution to the wind in regards to the TREBLE control is when you are looking for clipped Blues sounds in Channel 1 with the GAIN cranked. The additional gain that is added by running the TREBLE high (1:30 – 2:30) can help to saturate the Modes in Channel 1 enough to get some great pushed sounds. You will have to run the BASS rather low (8:30 – 9:30) to keep things tight.

NOTE: In the EDGE Mode of Channel 2 it may be necessary to run the TREBLE a little lower than normal(10:30 – 11:30) to achieve a warm balanced sound as there is a substantial amount of aggressive top end inherent in this Modes' character.

FRONT PANEL: THE CONTROLS (Continued)

NOTE: The MARK I Mode in Channel 2 responds well to slightly higher TREBLE settings (1:30 – 2:30) when looking for high gain chording and single note solo sounds. This scheme adds gain in the right place, focus and tighter-tracking pick response.

NOTE: High settings of the TREBLE (2:30 – 5:30) can put extra stress on (even borderline) microphonic preamp tubes (ones that are susceptible to high pitched ringing and noise) and cause them to begin ringing or show other signs of instability. Many tests were run on the set of tubes that shipped in your **MARK V** to ensure they were stable at the time of construction. However, tubes are not perfect devices – much like light bulbs – and can change over time and become more microphonic. Luckily you can remedy most tube problems with a simple tube swap. Avoid these settings (especially in Combo amplifiers – where the added sympathetic and vibrational forces put even more stress on the tubes) to ensure trouble free performance.

MID:

The MID control acts much more like a standard tone control and doesn't have quite the massive global shaping power of the VOLUME and TREBLE controls, yet its setting does impart a strong character on the sound of all three Modes. It brings in and out a broad band of midrange frequencies and - as we have mentioned earlier - along with these rides a fair amount of higher "low treble" range frequencies. These highs are lower than that of the TREBLE or PRESENCE but they are important for the punch and cut of the amplifier in a mix.

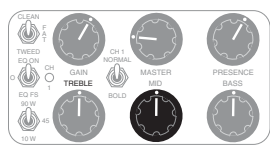

For rhythm playing in the CLEAN and FAT Modes of Channel 1, a lower MID setting (7:30 – 10:00) scoops some of this midrange attack and makes the bottom end breathe more. This range will also make things more resilient and create an easier to play, more elastic feel on the strings. Single coil guitars work very well here for the slinky, rubber band attack and bouncy bass character associated with Blues, R&B and Country clean styles.

The middle region (10:00 – 1:00) is where the punch and attack begin to come on with more urgency and this is where mahogany guitars really like to see the MID set for adding the cut and definition. Here the top end begins to creep into the mix of the MID controls' spectrum and chording sounds start to chime and slash with a more forward – and very present – character.

From here on up (1:00 – 5:30) the MID introduces an aggressive range of sounds that are both full and quite forward as the dominant frequencies become those present under control of the MID. In this range you will likely have to increase the BASS to add back in the richness and warmth that gets overshadowed when the MID control is set high. If you like the attack and urgency found in this range of the MID, all the other controls (except maybe the MASTER, which you may have to back down as the sound gets more forward) may have to be set higher to keep up with the MID dominant curve. This is fine although there will reach a point of diminishing return as the headroom in the preamp gets eaten up by this tonal arms race and you begin to clip the preamp with the high signal from the Tone control string.

For gain sounds in the Channel 2 and 3 Modes a similar story unfolds as the MID is increased. Lower settings (7:30 – 10:30) will produce wider sounding, more elastic feeling chordal sounds and the single notes will have a more creamy, smooth character. High harmonics created by the gain and controlled largely with the TREBLE and PRESENCE, will put a patina of three-dimensional haze on things that smears with vintage soul. As the MID is increased past this region, more thick "gut punch" and low-Treble region attack creeps in and the sound becomes more forward.

NOTE: Be sure to experiment with the MID in all the gain Modes of Channels 2 and 3, paying special attention to the feel as well as the sound. The MID really changes the dynamic content as well as how the strings feel to play. The EDGE and CRUNCH Modes of Channel 2 really can be shaped radically by the setting of the MID. Lower settings here work well for more creamy, scooped single note solo sounds, where as higher settings deliver Classic Rock crunch rhythm sounds that kick ass with authority, punch and detail.

FRONT PANEL: THE CONTROLS (Continued)

BASS: Much like the MID, the BASS control responds like a typical Tone control and blends in a fairly wide slice of rich bottom end to round out the sound. Internal switching that occurs when the different Modes are selected re-voices both the location and the frequency of bass present for each of the nine circuits (Modes). This difference is crucial to the sounds and a big part of their character.



The CLEAN and FAT Modes of Channel 1 incorporate a much lower bass frequency that adds depth, dimension and air to the sound and needs a much slower taper pot to balance this huge low end with the sounds in the higher gain circuits. The TWEED Mode in Channel 1 and most all the Modes in Channels 2 and 3 (except MARK I in Channel 2 which uses a large amount of a very low frequency) utilize a much higher bass frequency. This produces a more resonant, thumping quality and keeps things tracking tighter and gives gain sounds a more bouncy alive feel. These higher frequencies can be used in greater proportions as compared with the lower – and possibly more tone-dangerous – frequencies used in the CLEAN, FAT and MARK I Modes because they have less of a tendency to slow things down or get in the way during faster playing.

You can really utilize higher settings of this higher frequency on the BASS control in the EDGE Mode of Channel 2 and the EXTREME Mode of Channel 3 where there is a huge amount of high- mid/low-treble attack in the sound. Try running the BASS in the 11:00 – 1:30 range in these two Modes for some huge crunch rhythm sounds.

In the MARK I Mode of Channel 2 you will need to be especially sensitive with the BASS control as this Mode utilizes a very low frequency of bass in the circuit – which is an integral part of this Modes fat character. Because of this extended low-end single notes sound huge and warm and high gain chording sounds come at you like a giant, thick, wall of crunch. We recommend setting the BASS control in the low end of its' sweep (7:30 – 10:00) for both single note and chording sounds whenever high GAIN settings are in place. You can take a little more liberty with BASS settings (10:00 – 11:30) as the GAIN is decreased to add breath and fullness to purring pushed rhythm and Blues solo sounds.

Now that we've covered the Channels, the Modes and their Controls we can move on to the many other Features of your *MARK V* that will be invaluable to creating your individual and unique voice.

FRONT PANEL: FEATURES

OUTPUT & SOLO:

This section determines the overall output level (playing volume) of the **MARK V** only when the Rear Panel EFX LOOP is engaged (switch up – LOOP ACTIVE position) and the Effects Loop is in the signal path. As mentioned earlier, when the Effects Loop is in HARD BYPASS – switch down, the individual Channel MASTER controls function as the final output control for each individual Channel. These controls appear in the last stages of the power amp – late in the signal path – and also act as Effects Return control, not that you need to be especially aware of this, just crank the amp up to the desired playing level. Use the individual Channel MASTER controls to balance the volume levels between the three Channels as you footswitch through them and then you can raise or lower the whole amp by using the one OUTPUT control. You may have to readjust the levels between the Channels as you increase the OUTPUT and the volume gets loud. This is because some Modes (sounds) react with a more dynamic character (for example clean and lower gain sounds) than others (high gain sounds) as the volumes get higher.

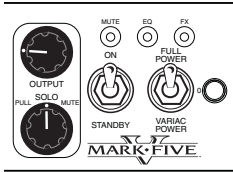

The **MARK V** incorporates another patented feature that comes in very handy in live performance applications, and that's the addition of the SOLO control. This control is wired in series with the OUTPUT control and provides an additional OUTPUT level control that you can footswitch to for a pre-determined amount of volume boost for passages where you want to feature a part or take a solo. No longer do you have to rely solely on the Front Of House engineer to catch your spotlight section and bring you up a bit in the mix... the SOLO feature puts that call back in your control.

The SOLO control is activated by the SOLO button on the **MARK V** FOOTSWITCH and remains inactive (has no effect on the volume) when the FOOTSWITCH is not connected to the Rear Panel FOOTSWITCH DIN jack. SOLO can only be activated by the FOOTSWITCH.

NOTE: The SOLO control can only be used to achieve a volume level above (louder) than that already set by the OUTPUT control. It may not be used to achieve a level lower than that determined by the OUTPUT control.

SOLO: PULL MUTE

The SOLO control utilizes a pull pot to engage the TUNING MUTE Feature and kill the signal at the Speaker OUTPUT so that you can tune the instrument in SILENT MODE during performance. Connect your tuner to the Rear Panel 1/4" TUNER OUTPUT jack located on the right side (facing rear) of the Rear Panel just below the SLAVE OUTPUT and simply pull the SOLO control to engage the SILENT TUNE Mode. When you are finished tuning simply push the SOLO control back in to resume playing.

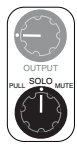

The PULL MUTE feature can be used any time you have the Effects Loop engaged and in the signal path to mute the sound for other applications such as patching cables. We recommend using the STANDBY for longer periods of silence as this will prolong the tuneful life of your power tubes.

NOTE: The TUNER OUTPUT and its' PULL MUTE feature does not work when the EFX LOOP is in HARD BYPASS (toggle – down) as the SOLO control is part of the EFX Loop circuit.

FRONT PANEL: FEATURES (Continued)

LED INDICATION:

These three LED lights keep you informed of the status of the MUTE, EQ SECTION and EFX LOOP and are illuminated when any of these features are active. This comes in especially handy in larger venues when you may be farther away from your amplifier and need to be informed with a quick glance over the shoulder as to the status of these features.



NOTE: The MUTE and EFX LOOP only are active when the EFX LOOP is in LOOP ACTIVE (toggle up) Mode.

STANDBY:

Perfect for set breaks... this toggle switch also serves an even more important purpose. In the Standby position the tubes are at idle so that during power up they may warm up before being put to use. Before Power is switched on make sure the **STANDBY** switch is in the Standby position. Wait at least 30 seconds and then flip the **STANDBY** switch to the ON position. This prevents tube problems and increases their toneful life substantially.



FULL POWER / VARIAC POWER:

This global switch performs two functions; it determines the flow of AC Power from the wall receptacle and can also be used to switch the entire amplifier down to a reduced voltage power mode for a looser, more elastic feel.



FULL POWER supplies the amplifier with the full 120 volts of voltage (depending on line conditions at any given time) and produces the maximum volume, headroom and punchy bold tone throughout the Channels.

VARIAC POWER limits the incoming AC Voltage to roughly 95 volts (again depending on line conditions) for a “browner” power vibe. This position scoops the midrange and provides a looser more elastic feel on the strings with some shifting (up) of the higher harmonics as well. This can be cool for sounds that rely on output (power amp) clip for their character... pushed clean, Roots, Blues or Classic Rock Rhythm sounds can all benefit from this softer power feel. When used in conjunction with the 10 WATT power setting, the **MARK V** can deliver the ultimate in saggy, low power performance.

For all-around gigging applications we recommend the FULL POWER setting as this delivers the greatest headroom for clean sounds as well as the most focused and tight-tracking overdrive sounds.

NOTE: Some locations have very low voltage present at the AC wall receptacle (old clubs, outdoors, homes in areas of heavy manufacturing business) and if you either suspect – or test and find this to be true – we recommend using the FULL POWER setting. If the voltage gets too low, you may experience intermittent switching problems when in the VARIAC POWER Mode - use FULL POWER in areas of less-than-optimum AC power to help avoid this annoyance.

Now the Front Panel is under your control and you are free to run loose in Tone-land. We hope you enjoy exploring the **MARK V** as much as we do... it should provide you with years of inspiring discovery. Now let's go around back and check out the features located on the Rear Panel

REAR PANEL: FEATURES

REAR VIEW: *MARK V*™

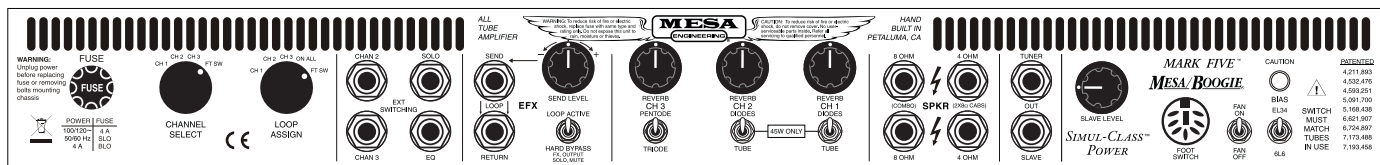

FUSE: This is the A.C.'s (Alternating Current) main fuse and provides protection from outside A.C. fluctuations as well as power tube failure damage. Should the **FUSE** blow, replace it with the same rating in a Slo-Blo type package. The Domestic 117V and Japanese 100V versions requires a 4 amp Slo-Blo fuse. A power tube short or failure is often the cause of a blown fuse... Follow the cold start procedure mentioned in the STANDBY switch section and watch the power tubes as you flip the STANDBY to the ON position. If a power tube is going bad or is arcing you will see it! Flip the STANDBY switch down immediately and replace the faulty power tube and the **FUSE** if necessary.

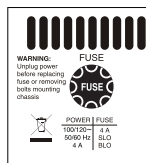

If you see nothing abnormal as you lift the STANDBY switch, it is possible that a power tube shorted temporarily and blew the **FUSE**. If this is the case it may work again normally. To be safe, you might want to replace just the adjacent tube or all power tubes in the "shotgun" troubleshooting tradition and save the replaced set as spares. Spare fuses are a must for the fabled cord bag along with your spare tubes. Always carry both for they could be worth their weight in gold someday.

EXTERNAL SWITCHING: These four jacks are provided so that you may control the 3 Channels, the EQ and the SOLO feature with an external master Switching device. This is essential to use the *MARK V* as part of a Midi rig where all sounds are called up via a Midi Foot controller and both amplifier and effects settings are stored under a midi program number. The logic used to trigger these ports is simple tip-to-ground, latching type and most Master switching systems incorporate several jacks dedicated to this logic.

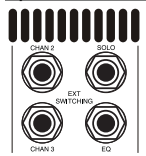

The **EXTERNAL SWITCHING** jacks override the *MARK V's* Foot controller. Once a Channel or Feature has been triggered "On" at the EXT. Switch ports, it may not be controlled or turned "Off" until the logic at the Switch Port is reversed.

EFX LOOP: Series The *MARK V* handles outboard processing by providing an on-board patch point between the preamp and power section. This loop is wired such that the dry signal is in series with the effected (wet) signal. The circuit also incorporates a **SEND LEVEL** control allowing you to fine tune the output of the preamp circuit to match the input sensitivity of your processor (or first processor in a rack system). The **EFFECTS LOOP** circuitry can be completely removed from the signal path with the **HARD BYPASS/LOOP ACTIVE** mini toggle. This removes all associated loop circuitry from the chain and ensures the purest signal path and maximum sonic performance when outboard processing is not being used. The **SEND** and **RETURN** jacks incorporate switching elements so that you may use the **LOOP ACTIVE** selection and activate the Front Panel OUTPUT and SOLO controls with nothing connected to the Loop.

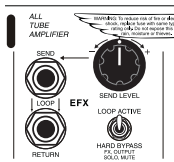

NOTE: The Front Panel OUTPUT and SOLO controls are both part of the Loop and therefore active only when the Effects Loop is engaged. They are both part of the Return stage and will remain inactive as long as the loop bypass mini toggle is set to **HARD BYPASS**.

REAR PANEL: FEATURES (Continued)

To connect your outboard processor(s) to the Effects Loop:

1. Connect the **SEND** jack on the *MARK V* Rear Panel to your processor's INPUT using a high quality shielded cable of the shortest possible length.
2. Connect the **RETURN** jack of the *MARK V* to your processor's OUTPUT also using a high quality shielded cable of the shortest possible length.
3. Adjust the **SEND LEVEL** control on the Rear Panel of the *MARK V* to achieve an adequate match on the INPUT level indicator of your processor. Adjust the processor Output level stage (hopefully your processor has an OUTPUT LEVEL control) to match the volume present before connecting the device(s) to the *MARK V*. You can check this by simply removing both the cables from the **SEND** and **RETURN** simultaneously.
4. Use the Front Panel OUTPUT control to raise and lower the overall volume as it is essentially an Effects Return Stage volume control.

NOTE: It is normal to experience some amount of change to the sound when using the **EFFECTS LOOP**. Normally this is minimal and most often appears as a subtle roll off in top end characteristics. This is a series loop and therefore the results you get using it greatly depend upon the quality of the devices you insert into the loop. We strongly suggest taking your amplifier and trying any processor before buying it to make sure it is compatible with the *MARK V*. Normally, the more professional series lines of most companies building outboard gear work well. However we have seen even so called pro stuff produce less than satisfactory results in terms of tonal thievery.

NOTE: Engaging the **EFFECTS LOOP** circuitry adds a substantial amount of circuitry and this additional circuit reverses the phase of the entire amp. This is no cause for alarm and if we hadn't told you of this, you probably would never have known. Sonically there is no difference other than the incredibly subtle difference in the sound the circuit itself adds.

The only time you will ever need to consider this reversal of overall phase is if you ever run the *MARK V* in Stereo with another amp (not another *MARK V* as it would be in phase with its Loop activated). In this case you would probably want to separate the two amplifiers by at least a few feet if not on the other side of the stage.

REVERB:

The *MARK V* boasts one of the best sounding Reverb circuits in the business and extensive switching of both the location in the circuit and the voicing of the Reverb are employed to ensure the most authentic rendition of each Mode. Individual REVERB mix controls for each Channel allow you to set the desired wet/dry of the rich all-tube Reverb effect for each Channel without compromise.

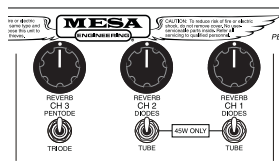

If you wish to bypass the Reverb simply turn the mix control off (7:30) and the dry signal will come through unaffected. The REVERB effect can also be taken in and out of the signal path with the REV button on the *MARK V* Footswitch.

NOTE: There is slightly less Reverb effect available in a totally wet mix setting (5:30) in Channel 2 than is available in Channels 1 and 3. This is due to the architecture of the Channel and the signal path of the Modes. Most likely you will not find this an inconvenience as Channel 2 is most often configured for overdriven rhythm parts and high gain lead work in the *MARK I* mode. The only time you may find that you have to run the Reverb control of Channel 2 much higher than those of the other Channels is in the *MARK I* Mode for lower gain Blues styles.

REAR PANEL: FEATURES (Continued)

SWITCHABLE RECTIFIERS: 45 WATT POWER MODE

Switchable Rectifiers makes its debut on the MARK Series for the first time here on the FIVE in the form of patented Rectifier Tracking™. Channels 1 and 2 are fitted with individual mini toggles (located under the Channel 1 and 2 REVERB Controls) that allow you to choose between the tight, bold, higher-headroom response of Silicon DIODES or the saggy, sweet, low-output looseness of TUBES (Tube Rectifier) in the 45 Watt Power Mode. Channel 3 utilizes Silicon Diodes all the time as the amplifier circuits it contains all used Silicon Diodes.

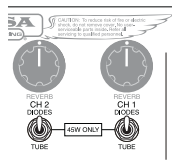

The Simul-Class™ 90 Watt Power Mode automatically selects the big power punch of the Silicon Diodes and the Single Ended, Class A 10 Watt setting requires the Tube Rectifier to operate safely. The rectifier circuit converts the incoming A.C. voltage to D.C. for the tubes to run on and the type of rectification has a big impact on the sound and feel of the amplifier.

DIODES deliver the maximum headroom, attack and dynamic content and track tighter – especially in the bass region. Diodes work great for clean chording sounds in Channel 1 and tight-tracking crunch rhythm sounds in Channels 2 and 3. Lead sounds will be more explosive and focused and deliver the greatest articulation.

TUBE slows things down, reduces headroom, smooths things out and scoops upper midrange along with producing a more elastic, bouncy feel on the strings. Tube rectification is great for threshold of distortion sounds on rhythm parts and vintage style single note soloing. TUBE also re-voices the top end raising it up an octave and making it a little recessive at the same time.

CHANNEL 3: TRIODE / PENTODE

A PENTODE / TRIODE mini toggle switch (located just under the CH 3 REVERB Control) allows you to choose the wiring configuration of the middle pair of power tubes in Channel 3 only. This is a feature that was popular on the MARK 4 and changes the personality of the attack and liquidity of the sound in the higher gain condition found in Channel 3.



This switch re-wires the configuration of the Class A pair of output tubes (inside two 6L6's) to produce a radical sound and feel difference in the Modes (only in Channel 3). We have found many players like it only one way – citing that it makes or breaks the vibe for them or that they can't play as well when it's not set to their favorite way. We feel it is a powerful stylistic parameter and should be explored fully for its usefulness to your sound.

TRIODE softens the midrange attack and accentuates the upper harmonic region creating a silky, more compressed - almost liquid feel - and lowers overall power output. This setting tends to raise the harmonic haze and sweeten the top end and it shines for expressive high gain solo work or high gain chording that is more textural than rhythmic. It offers more complexity and nuance, but the trade-off is that it may not cut through a mix as well. TRIODE produces less overall power output so it is probably not the choice for very low gain chording unless you are looking for more of a "vintage sag" feel. All original MARK II-C+ amplifiers were hard-wired to TRIODE whereas the MARK IV offered a choice between these two configurations.

PENTODE accentuates midrange punch and lowers the upper harmonic region for a bolder, tighter attack – especially in the low end – and increases output power and headroom. PENTODE delivers a much more immediate dynamics with greater peaks and feels "faster" to play... almost anticipating your next input. This urgent attack means that PENTODE excels at any style where rhythmic nuance and tight-tracking accuracy are essential. This is probably the best choice for solo sounds that pop through a mix and high gain crunch chording that is defined and articulate with huge tight low-end.

REAR PANEL: FEATURES (Continued)

SPEAKERS: Two 4 Ohm and two 8 Ohm jacks are provided for speaker interfacing. The *MARK V* is not very sensitive to speaker mismatches and will not be damaged by them, except that very low ohmage loads will cause the power tubes to wear faster. A single twelve-inch 8 Ohm speaker should generally be connected to an 8 Ohm output. When using two 8 Ohm speakers, connect them both to the 4 Ohm outputs provided (because the total load is 4 Ohms in that case.) Check out the information further back in this manual regarding speaker impedance and possible speaker hook-up schemes.

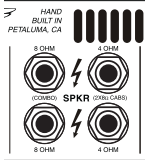

4x12 cabinets may be 4, 8 or 16 Ohms. If you are not sure of the impedance of your cabinet, you may need to remove the Rear Panel in order to verify the impedance rating of the individual speaker or speakers. *MESA* 4x12 and 4x10 cabinets come standard wired to 8 Ohms, and are wired in series-parallel. Some Non-*MESA* 4x12 cabinets are wired 16 Ohms using four 16 Ohm speakers. By wiring all four speakers in parallel, you can reduce the cabinet to an impedance load of 4 Ohms (assuming the speakers are 16 Ohms each.) No matter how unusual your speaker setup, it is always possible to get good performance.

TUNER OUT: This jack located above the SLAVE jack is a Tuner Output and allows for silent tuning in live stage or studio environments where it is essential to tune your instrument without sound. When a Tuner is connected to this jack, tap MUTE on the Foot Controller and the signal to the speakers will be muted. The signal will remain muted until you tap MUTE again to bring the signal back.



NOTE: The *EFX LOOP* switch must be set to *LOOP ACTIVE* for the *MUTE* function of the Foot Controller to work properly.

SLAVE: This 1/4" jack and control provide a signal derived from the speaker jack. Perfect for using either the *MARK V* head version or combo as a master pre-amp and additional power amps for more power when needed. Some players use the *SLAVE* to derive an *EFX Send* Signal and go to other amps for their wet sound.

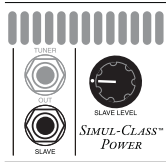

NOTE: Once a signal is taken from the *SLAVE*, it can not be inserted back into the *EFX Loop Return* jack or a feedback loop will occur. Much like holding a microphone into a PA system's cabinets...a loud high pitched squeal will be the result.

BIAS SELECT: This mini toggle allows for proper biasing when swapping to EL34 type power tubes for a brighter harmonic laden response. It selects a different set of bias resistors and insures that these extremely different power tubes will sound better and work much more reliably. The adjacent LED indicator alerts you that the bias has been set to accommodate the EL34's.

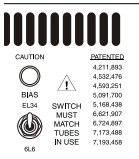

NOTE: It is extremely important that the *BIAS SWITCH* setting match the type of tubes in use. Failure to comply will result in damage to your amplifier. Always check the *BIAS SWITCH* whenever swapping tubes!

Regardless of the type of power tube you choose, we strongly suggest keeping at least one spare set of tubes and a bag of extra fuses with you at all times should a power tube fail when performing. A little preparation will save you a lot of frustration.

NOTE: Using the *AC POWER* switch set to *VARIAC POWER* will reduce the strain on EL34 tubes (and 6L6 as well). If you prefer the sound of this setting, you will reduce the likelihood of tube problems and greatly extend their toneful life, as they are basically coasting.

FACTORY SAMPLE SETTINGS

Workhorse

CLEAN F+
EQ ON CH1
EQ FS 1
MARK I H
GAIN
TREBLE
BOLD
NORMAL
CH1
MASTER
MID
PRESENCE
BASS

EDGE C R N H
EQ ON CH2
EQ FS 2
MARK I H
GAIN
TREBLE
MARK I
NORMAL
THICK
MASTER
MID
PRESENCE
BASS

MARK V C EXTREME
EQ ON CH3
EQ FS 3
MARK I H
GAIN
TREBLE
BRIGHT
NORMAL
CH3
MASTER
MID
PRESENCE
BASS

SCHEM
1
2
3
PUSH TO SOLO
MUTE
EQ
FULL POWER
VARIABLE POWER
MARK FIVE

240 750 2200 8600

Tight, Urgent, Sing

CLEAN F+
EQ ON CH1
EQ FS 1
MARK I H
GAIN
TREBLE
BOLD
NORMAL
CH1
MASTER
MID
PRESENCE
BASS

EDGE C R N H
EQ ON CH2
EQ FS 2
MARK I H
GAIN
TREBLE
MARK I
NORMAL
THICK
MASTER
MID
PRESENCE
BASS

MARK V C EXTREME
EQ ON CH3
EQ FS 3
MARK I H
GAIN
TREBLE
BRIGHT
NORMAL
CH3
MASTER
MID
PRESENCE
BASS

SCHEM
1
2
3
PUSH TO SOLO
MUTE
EQ
FULL POWER
VARIABLE POWER
MARK FIVE

240 750 2200 8600

Fat Lady

CLEAN F+
EQ ON CH1
EQ FS 1
MARK I H
GAIN
TREBLE
BOLD
NORMAL
CH1
MASTER
MID
PRESENCE
BASS

EDGE C R N H
EQ ON CH2
EQ FS 2
MARK I H
GAIN
TREBLE
MARK I
NORMAL
THICK
MASTER
MID
PRESENCE
BASS

MARK V C EXTREME
EQ ON CH3
EQ FS 3
MARK I H
GAIN
TREBLE
BRIGHT
NORMAL
CH3
MASTER
MID
PRESENCE
BASS

SCHEM
1
2
3
PUSH TO SOLO
MUTE
EQ
FULL POWER
VARIABLE POWER
MARK FIVE

240 750 2200 8600

FACTORY SAMPLE SETTINGS

All Blues

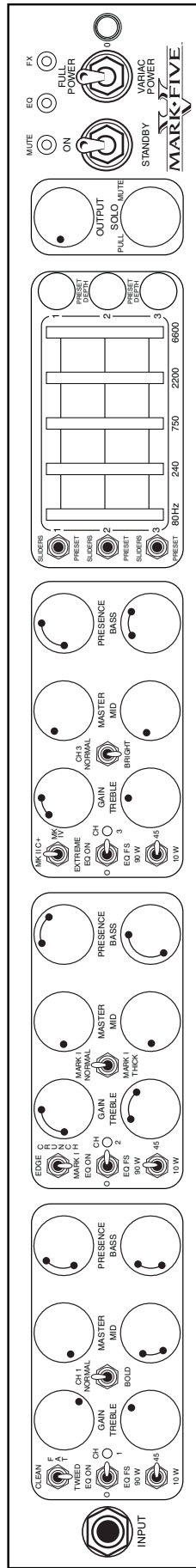

Attitude

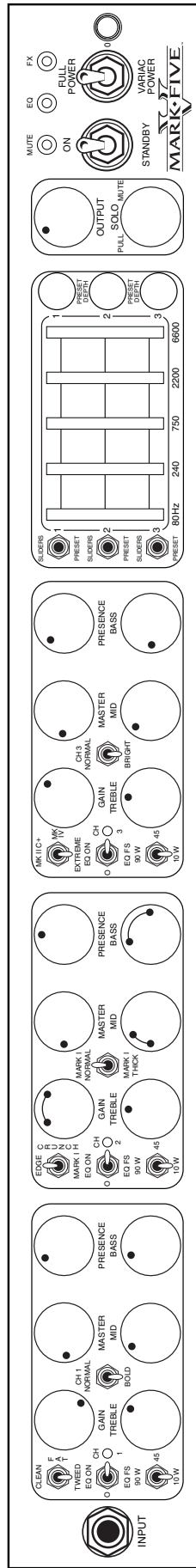

Gain & More Gain

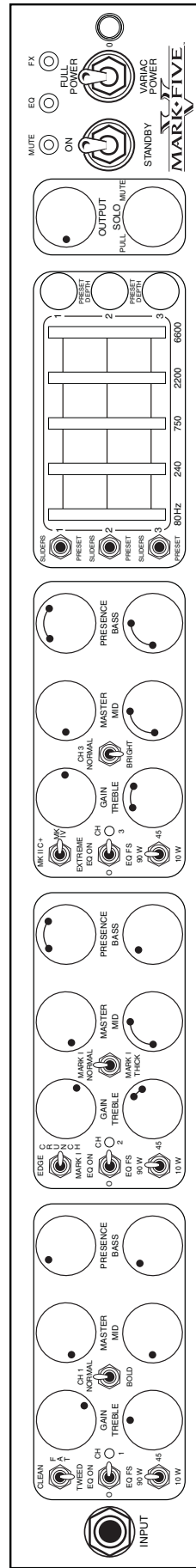

USER SETTINGS

INPUT

CLEAN
EQ ON CH1
EQ FS 1
EQ W 45
EQ V 15V

EDGE
EQ ON CH2
EQ FS 2
EQ W 45
EQ V 15V

MK4/C
EQ ON CH3
EQ FS 3
EQ W 45
EQ V 15V

SCORCH
EQ ON CH3
EQ FS 3
EQ W 45
EQ V 15V

Output: OUTPUT, FULL, SOLO, MUTE

Buttons: MUTE, ON, EQ, FULL POWER, VARIC POWER

INPUT

CLEAN
EQ ON CH1
EQ FS 1
EQ W 45
EQ V 15V

EDGE
EQ ON CH2
EQ FS 2
EQ W 45
EQ V 15V

MK4/C
EQ ON CH3
EQ FS 3
EQ W 45
EQ V 15V

SCORCH
EQ ON CH3
EQ FS 3
EQ W 45
EQ V 15V

Output: OUTPUT, FULL, SOLO, MUTE

Buttons: MUTE, ON, EQ, FULL POWER, VARIC POWER

INPUT

CLEAN
EQ ON CH1
EQ FS 1
EQ W 45
EQ V 15V

EDGE
EQ ON CH2
EQ FS 2
EQ W 45
EQ V 15V

MK4/C
EQ ON CH3
EQ FS 3
EQ W 45
EQ V 15V

SCORCH
EQ ON CH3
EQ FS 3
EQ W 45
EQ V 15V

Output: OUTPUT, FULL, SOLO, MUTE

Buttons: MUTE, ON, EQ, FULL POWER, VARIC POWER

BIAS ADJUSTMENT: *(Part of a continuing series)*

An Article written by Randall Smith that we thought you might find interesting.

Here's a question we often hear:

"Why doesn't *Mesa* put bias adjustments in their amplifiers?"

Well, there's a short answer and a long answer to this question.

The short answer is that during my 12 years of repairing Fenders, one of the most frequent problems I saw was bias controls that were either set wrong or that had wandered out of adjustment due to vibration. As any honest tech will tell you, there's lot's of easy money to be made by sprinkling "holy water" on amplifiers ... uh, what I meant to say is "Your amp needed biasing." See what I mean? What customer is going to argue with that?

It only takes a moment and a volt meter: The Fender diagram shows how: "Adjust this trim pot for - 52 volts." That's it. Nothing more.

Now don't be fooled into thinking that tubes "draw" more or less bias, they don't. The way a bias supply is connected to a tube is akin to a dead end road, it just trails off to nowhere without really completing a circuit. It's a static voltage and regardless of what tube is in the socket — or even if the tubes aren't plugged in at all, it doesn't change the bias voltage a bit.

So the end of the short answer is this: Since a bias supply needs to put out the right voltage and never vary, I wanted to build amplifiers that were individually hard wired to the correct values and NEVER needed adjustment. And for 25 years, that's how *MESA/Boogies* have been built.

Time to change tubes? Just plug our tubes into any one of our amps and you're DONE. No tech needed. NO bills and no BS about biasing. And most important: The bias is RIGHT because it can't change!

Now, you want the long answer? Here's more information on how our hard-wired bias avoids trouble. Please read on.

But first, let's make an important distinction. Our business is designing and building high performance amplifiers. And for this we need tubes whose variance is within a narrow range. Our warehouse is full of rejects ...oh, they work — they just don't perform within our tolerance range. We have a very sophisticated computer - based tube testing system (nicknamed "Robotube") that matches and measures tubes over seven important parameters. It can even predict which tubes are likely to have a shortened lifetime — even though they work perfectly during the test.

Because our business is building quality amps, we can afford to reject a lot of wayward tubes. The guys you hear complaining because *Boogies* don't have bias adjusters are primarily in the business of selling tubes - not amps. They don't want to throw away 30 percent of their inventory, so they promote the idea that tubes outside our parameters can be used to "customize" amplifiers and they criticize us because our amps can't be adjusted to accommodate their out-of-*MESA* tolerance tubes.

Now you might be thinking, "But I thought you just said that tubes don't "draw" bias, therefore they don't effect the bias supply and thus it doesn't need to be adjustable." When you set the bias (whether it's by selecting the right resistors, as we do, or adjusting a trimmer — which is quicker) what you are doing is establishing the correct amount of idle CURRENT that flows through the power tubes. But you can't adjust the current directly, you can only change it by adjusting the amount of bias VOLTAGE that goes onto the tube's

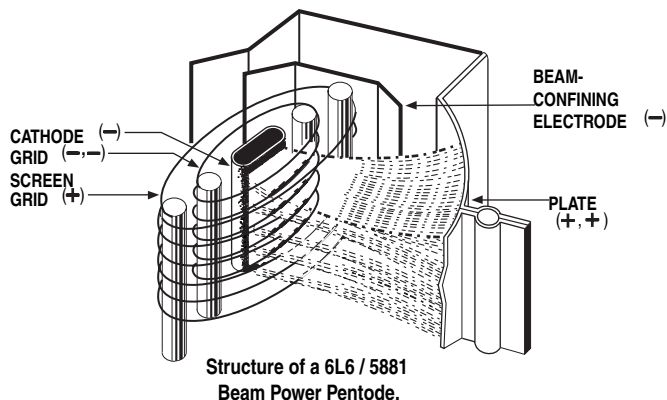

BIAS ADJUSTMENT: *(Continued)* control grids. Voltage and current are NOT the same. Current is the AMOUNT of electricity, the “quantity” — and is measured in amperes. Voltage is the degree of electric charge — like the “pressure” to use the old water analogy. Let me illustrate how different voltage and current are:

When you scrape your feet across a carpeted floor in dry, wintery conditions, your body can become charged with 50,000 to 100,000 volts of static electricity. And when you reach for the door knob, a spark jumps and you feel it! The voltage is super high but the current (measured in micro-amps) is tiny - otherwise you would die from electrocution.

Contrast this with your car battery, which puts out a mere 12 volts. You can lay your hands right across the terminals and not feel a thing. Yet the amount of current available can run to several hundred amperes .. enough to turn over a cold engine and get it started.

So current and voltage are two totally separate electrical parameters — though when you multiply them together, you get POWER, which is measured in watts.

When you set the bias of an amplifier, you are adjusting the static VOLTAGE at the control grid of the tube in order to produce a desired amount of idle CURRENT flowing to the tube’s plate. A small change in grid voltage, produces a large change in the amount of current flowing — and that’s basically how a tube works. Say that again because it’s super important: A small change in voltage at the grid causes a large change in current flowing to the plate. See, that’s the essence of amplification: A small change causing a large change. And here it’s a small voltage change causing a large current change.

The bias conditions are what determines how much current flows through the big power tubes when you’re not playing. And what drives your speakers is fluctuations in that current flow when you ARE playing. If the amount of current increases and decreases 440 times per second, then you’ll hear an A note. If the fluctuations in current flow are large and still at 440 per second, you’ll hear an A that is LOUD!

But for purposes of biasing, it’s the amount of “plate current” flowing with no signal applied that’s important. Unfortunately current is hard to measure because the circuit must be interrupted — as in “cut the wire” — and the meter spliced “in series” with the broken circuit. But measuring VOLTAGE is easy. It is not necessary to interrupt the circuit because a voltage reading can be taken in PARALLEL with the circuit intact.

Thus, as a matter of convenience, most bias settings are given in volts at the grid ... even though current through the plate is the important factor. In fact plate current is so inconvenient (and dangerous) to measure that Fender doesn’t even state what the correct value should be. They only give the grid voltage that will produce that current. (That’s the minus 52.) But that only happens if the tubes being used are “in spec.”

As long as the tubes ARE “in spec”, the right bias voltage will always give the correct plate “CURRENT” — but then there’s no need for the bias voltage to be adjustable!

If the tubes are NOT in spec, then the only proper way to re-set the bias is to cut the circuit and measure the current while adjusting the bias ... but no manufacturer I know even STATES the desired current value! Be that as it may, when the original bias voltage is altered far enough, it will compensate for the tube’s abnormal performance and the correct amount of idle current flow may then be restored. Clearly this is something most repair techs should not attempt.

Some newer amps have LED indicators connected to the circuit which will turn on when the right threshold of current flow has been reached. This is an improvement, and almost worthy if you’re willing to accept resistors and lights added into your amplifier’s audio path — which we aren’t.

The other “advantage” of this system is that it allows some amp manufacturers to avoid matching their power tubes. The thinking is that adjusting the bias to each tube separately eradicates the inherent differences between the tubes by insuring that the same current flows through each one.

BIAS ADJUSTMENT: *(Continued)* Again, this has some merit .. but it's still not as good as using tubes that are matched in the first place because compensating for the mismatch causes the push-pull circuit itself to become unbalanced. Two wrongs don't really make a right.

Some of the other recommended biasing, "methods" — such as -".. tubes running red hot, increase the bias .. sounds harsh and runs too cool, turn it down ..." are guesswork at best. Luckily, one of the great things about tube amps is that they can usually stand some abuse without causing any real harm ... at least not immediately. But don't these alterations imply that you are second-guessing the amp designer and that there's a better set of operating conditions that the designer missed but the tube sellers have discovered?

Now some players may like the sound of their amp altered by tubes with extreme characteristics and with the bias set to help compensate. But often it is the mere novelty of change that they're really responding to and when the amp goes back to the proper original way, we've seen them be far happier still!

Because every part in every one of our designs has been meticulously evaluated, compared and stressed over — no matter how seemingly insignificant it might be. And with every design we look for a "sweet spot" where all the parameters — including the bias — come together to give the best sonic performance, consistently and reliably. Every part and voltage is important — yet no one complains that these other parameters aren't available for tinkering.

Consider our patented *Simul-Class*TM circuitry where there are two different bias voltages used for separate pairs of power tubes ... and changing one voltage also changes the other. Great care goes into getting this just right and we think we'd be asking for trouble to have it adjustable for the world to play with ... unless you like paying to have your amp messed up. Sorry, I meant to say, "Uh, ... your amp needed biasing."

If that doesn't appeal to you, then merely plug a matched set of *MESA* tubes into one of our amps and you're ready for tone. Guaranteed. You'd be amazed at the number of service calls we field every day that lead to a diagnosis of out-of-tolerance, non-spec tube problems. To think these would be prevented by including a bias adjustment is something of an insult to you and us. If you put the wrong size tires on your car, do you think changing the pressure will make them right?

Please, don't think this is a blanket indictment of the other guys selling tubes — it isn't. And their tubes aren't all bad either. It just doesn't make sense to pay more of your hard earned cash for tubes that were probably made in the same Russian or Chinese factory and which have the possibility of being outside the performance window we select for your amp. And it pains us to hear the hype and mystique built up around biasing when twenty-five years of evidence affirms our decision to make bias circuits that "never need adjustment". How much money and trouble that has saved *MESA/Boogie* players you couldn't estimate.

Our rigorously tested and hand selected tubes are available at your nearest *MESA/Boogie* Pro Center or from us directly. Nobody offers better price, quality or warranty than we do ... so why swerve?

Next time we'll talk about our part in developing the great Sylvania STR 415 type 6L6 and how we're on the verge of seeing something fairly close reappear on the market. Remember, we still have some of these super rugged mondo-bottles available for older amps — *Boogies* only please! Until then, Relax, Breathe and Nourish your soul!

Cheers!

MESA/Boogie Ltd.

TUBE NOISE & MICROPHONICS: You may occasionally experience some form of tube noise or microphonics. Certainly no cause for alarm, this quirky behavior comes with the territory and the Tone. Much like changing a light bulb, you don't need a technician to cure these types of minor user serviceable annoyances and in fact, you'll be amazed at how easy it is to cure tube problems...by simply swapping out a pre-amp or power tube!

First may we suggest that you set the amplifier up on something so that you can get to the tubes comfortably without having to bend down. It also helps to have adequate lighting as you will need to see the tube sockets clearly to swap tubes. **Use caution and common sense when touching the tubes after the amplifier has been on as they may be extremely hot!** If they are hot and you don't want to wait for them to cool off, try grasping them with a rag and also note that the glass down around the bulbous silvery tip is considerably less hot which makes it easier to handle. Gently rock the tube back and forth as you pull it away from its socket.

DIAGNOSING POWER TUBE FAILURE: There are two main types of tube faults: shorts and noise. Both large and small tubes may fall prey to either of these problems but diagnosis and remedy is usually simple.

If a fuse blows, the problem is most likely a shorted power tube and shorts can either be mild or severe. In a mildly shorted tube the electron flow has overcome the control grid and excess current flows to the plate. You will usually hear the amp become distorted and begin to hum slightly. If this occurs, quickly look at the power tubes as you switch the amp to STANDBY and try to identify one as glowing red hot. It is likely that two of a pair will be glowing since the "shorted" tube will pull down the bias for its adjacent mates, but one tube may be glowing hotter — and that one is the culprit. The other two are often fine — unless they've been glowing bright red for several minutes.

Because there is no physical short inside the tube (just electrons rioting out of control) merely switching to STANDBY for a few moments then back to ON will usually cure the problem...at least temporarily. Watch the tubes carefully now. Should the problem recur, the intermittent tube will visibly start to over heat before the others and thus it can be identified. It should be replaced with one from the same color batch, shown on its label. Call us and we will send one out to you.

The severe short is not nearly so benign. In the worst cases, a major arcing short occurs between the plate and the cathode with visible lightning inside the glass and a major noise through the speaker. If this is seen to happen, IMMEDIATELY turn the amp to STANDBY. By this time the fuse probably will have blown. Such a short is usually caused by a physical breakdown inside the tube including contaminate coming loose or physical contact (or near contact) between the elements. Replace it and the fuse with the proper slo-blo type and power up the amp using the power up procedure as we described earlier in this manual.

TUBE NOISE: Often caused by contamination within in a tube, the culprit can usually be identified, and by lightly tapping on the glass, you will probably hear the noise change. Hearing some noise through the speakers while tapping on the 12AX7's is normal however. And the one nearer the INPUT will always sound louder because its output is being further amplified by the second 12AX7.

The power tubes should be all but quiet when they are tapped. If crackling or hissing changes with the tapping, you have probably found the problem. To confirm a noisy power tube, merely put the amplifier on Standby, remove it from its socket and turn it back on. It will cause no damage to run the amplifier briefly with one power tube missing. You may notice a slight background hum, however, as the push-pull becomes unbalanced. Whenever you are trying to diagnose a suspect tube, keep your other hand on the POWER and STANDBY switches ready to shut them off instantly in the unlikely case you provoke a major short.

If you think you've located a problem tube but aren't sure, we recommend substituting the suspect with a new one just to be sure of your diagnoses. You will be doing yourself and us a big favor by just following the simple guidelines previously mentioned regarding tube replacement. You'll probably be successful with much less effort than is required to disconnect everything and haul the unit to a technician who will basically perform the same simple tests. If the tubes are still within their six-month warranty period, we will happily send you a replacement. Just note the color designation on the tube label so that we can send you the appropriate match.

DIAGNOSING PRE-AMP TUBE PROBLEMS:

Because your amplifier is an all tube design, it is quite possible that you will at some point experience minor pre-amp tube noise. Rest assured - this is no cause for alarm and you can take care of the problem yourself in a matter of minutes by simply swapping tubes.

Let us begin by saying; It is a "very good" idea to keep at least a couple of spare pre-amp tubes on hand at all times to insure uninterrupted performance. These minor pre-amp tube problems can take many forms but can generally be described in two categories: Noise and Microphonics. Noise can be in the form of crackling, sputtering, white noise/hiss and/or hum. Microphonic problems usually appear in the form of a ringing or high pitched squealing that gets worse as the gain or volume is increased thus are more noticeable in the higher gain "HI" modes. Microphonic problems are easily identified because the problem is still present even with the instruments' volume off or unplugged altogether - unlike pick-up feedback which ceases as the instrument is turned down. Microphonic noise is caused by mechanical vibration and shock: think of banging a microphone around and you'll understand where the word came from.

The best way to approach a pre-amp tube problem is to see if it occurs only in one specific mode or channel. This should lead you to the tube needing replacement. Then all that remains is to swap the suspect tube for a known good performer. If you cannot narrow down the trouble to a specific mode or channel, the problem may be the small tube that drives the power tubes which is operational in all modes and channels. Though rare, a problem with the driver tube would show up in all aspects of performance - so if you can't narrow the problem down to being mode or channel specific, you may want to try replacing the driver tube. Driver problems generally show themselves in the form of crackling or hum in all modes of performance and/or weak overall output from the amplifier. Occasionally an anemic driver tube will cause the amplifier to sound flat and lifeless, but this is somewhat uncommon, as worn power tubes are a more likely suspect for this type of problem.

Sometimes making the diagnosis is more trouble than it's worth and it's faster and easier to merely replace the small pre-amp tubes ONE AT A TIME with a replacement known to be good. But MAKE SURE you keep returning the tubes to their original socket until you hit the one that cures the problem. You'll notice that tubes located nearer to the INPUT jack always sound noisier...but this is because they are at the start of the chain and their noise gets amplified over and over by the tubes that follow. The tube that goes into this "input socket" (usually labeled V1) needs to be the least noisy of the bunch. The tube that goes at the end of the preamp chain - just ahead of the power tubes - can be quite noisy without causing any problem at all. The tubes in your amp have already been located in the most appropriate sockets and this is why you should NEVER pull them all out at once and ALWAYS swap them one at a time. ALWAYS return a perfectly good tube to its original socket. Also it's a good idea to put the amp on STANDBY when swapping tubes to reduce the heat build up in the tubes themselves and to prevent explosive noises (which can still occur even if you are pulling the tubes away from their sockets gently) from coming through the speaker.

Remember, take your time, be patient and chances are real good that you can fix your amp yourself by finding and replacing the bad tube. It kills us to see someone who has shipped their amp back to us...and all it needed was a simple tube replacement! If you must send back your amp, remove the chassis from the cabinet by unscrewing the four mounting bolts on the bottom top. The chassis then slides back like a drawer and comes out from the back. Remove the big power tubes and mark them according to their location from left to right 1, 2 etc. They need to be wrapped separately with plenty of wadded up newspaper around them and put in a smaller box within the larger carton. Remove the Rectifier tubes and wrap them also. You can leave the preamp tubes in or remove them and wrap them separately being sure to label their location. (See Tube Task Chart.)

To wrap the chassis, use plenty of tightly wadded up newspaper so there is at least six inches of "crush space" between the chassis and the cardboard box. Bubble wrap also works well, but please DON'T use styrene peanuts - they will shift during transit and get lodged inside your electronics as well as allowing your amp to end up at the bottom of the box unprotected and possibly damaged.

Pre-amp tubes don't normally wear out as a rule. Therefore, it is not a good idea to change them just for the sake of changing them. If there isn't a problem - don't fix it. If there is no result from your substitutions, it may be possible that you have more than one problematic tube. Though rare, this does happen and though it makes the troubleshooting process a little more intimidating, it is still possible to cure the problem yourself.

NOTE: *It is normal to hear a slight metallic ringing sound when tapping on the preamp tubes. As long as the tube does not break into oscillation or start crackling or any other form of bizarre noise, it is considered normal and functional.*

SPEAKER IMPEDANCE MATCHING & HOOK-UP GUIDE:

IMPEDANCE: Wiring up speakers to provide the most effective load and making sure that all of them are in phase will help in creating the best sound possible. This is not too difficult, as long as you understand a few things about loading and how to connect your speakers to provide an optimal resistive load.

MESA/Boogie amplifiers can handle 4 and 8 ohms effectively. Never run below 4 ohms in a tube amplifier unless you are absolutely certain that the system can handle it properly; this can cause damage to the Output transformer. A few amplifiers can handle 2 ohms effectively without damaging them (for example the *MESA'S Bass 400+*). You can always have a higher resistance (16 ohms, for example) without damaging results, but too low of a resistance will likely cause problems.

MIS-MATCHING: When running a higher resistance (for example: 8 ohm output into 16 ohm cabinet), a slightly different feel and response will be eminent. A slight mismatch can provide a darker smoother tone with a little less output and attack. This response is a result of the amplifier running a bit cooler. Sometimes when using more than one cabinet a mismatch will be the only option.

WHAT IS MY CABINETS IMPEDANCE: If you have only a single speaker, you just match that single speakers impedance to the amplifier, and you are done. In many cases, you will have a number of speakers, and then you must calculate the "load" that the amplifier will need to support. There are generally three ways to wire multiple speakers together. They are as follows:

SERIES: When you wire (hook-up) speakers in Series, the speakers resistance (as measured in ohms) is additive - i.e. putting two 8 ohm speakers in Series results in a 16 ohm load.

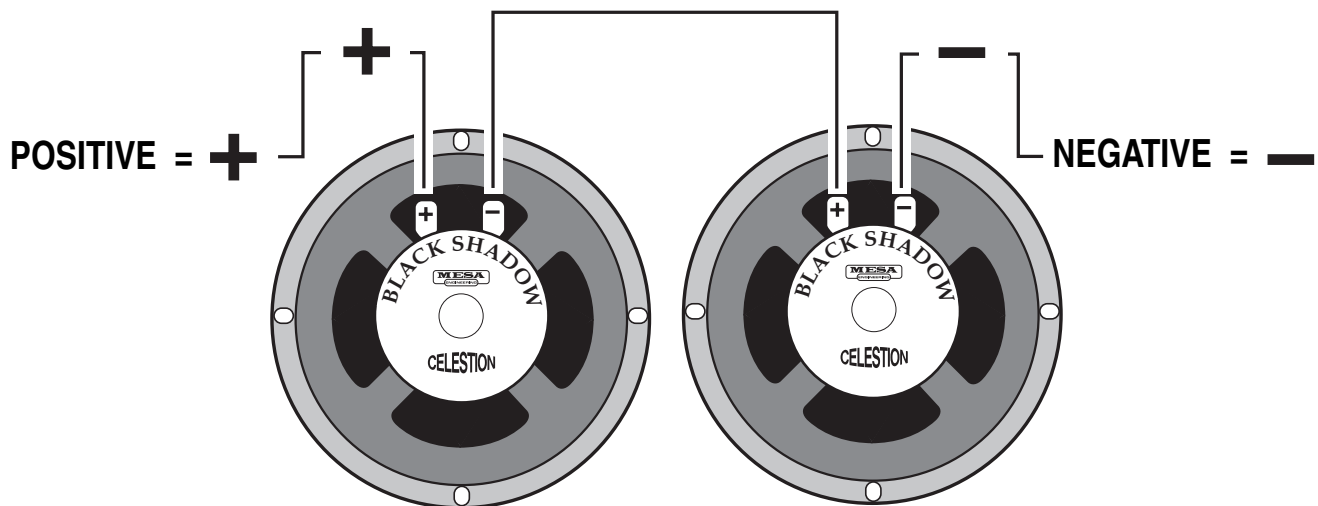

Speaker A = 8 Ohms

Speaker B = 8 Ohms

SERIES: Connect the Negative side of Speaker A
to the Positive side of Speaker B

SPEAKER IMPEDANCE MATCHING & HOOK-UP GUIDE: (Continued)

PARALLEL: When wiring in parallel, the resistance of the speakers decreases. Two 8 ohm speakers wired in (hooked-up) Parallel results in a 4 ohm load. It's easy to calculate the effect of a resistive load when all the speakers are all the same resistance. It is really not suggested to wire different resistive load values in Parallel (8 and 4, 16 and 8 etc.) The formula for figuring the total impedance in Parallel is the multiplication of the two loads divided by the sum of the two loads - i.e. putting two 8 ohm speakers in Parallel results in a 4 ohm load. Connect the Positive side of Speaker A to the Positive side of Speaker B - Connect the Negative side of Speaker A to the Negative side of Speaker B.

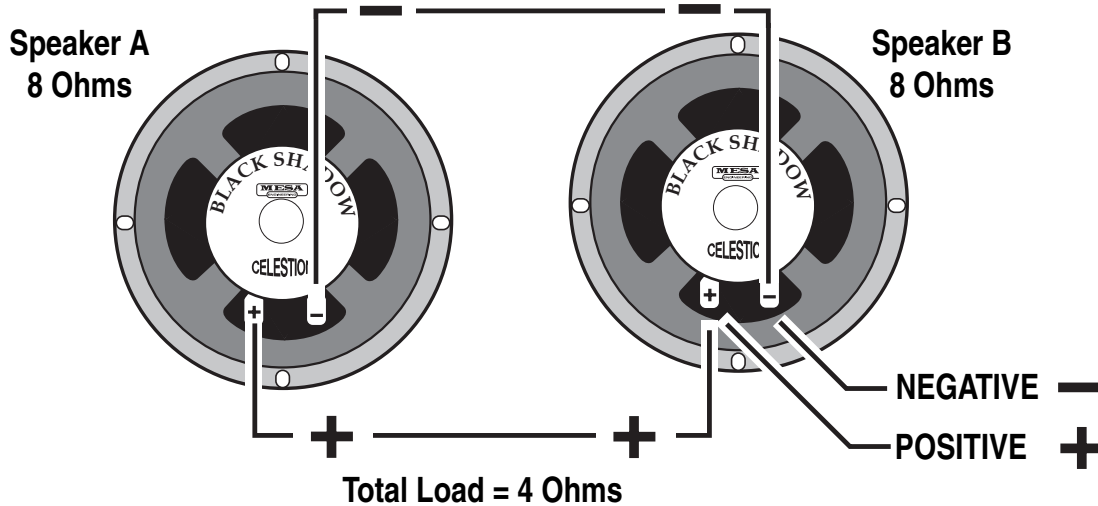

COMBINATION OF SERIES & PARALLEL: This is really just two sets of Series wired speakers connected in Parallel. This is how you maintain a consistent load with multiple speakers. The importance of this is more evident when you have more than one cabinet to connect to your amplifier. This is when you need to figure out the loads and how to wire them up without applying too low of a resistance on the amplifier.

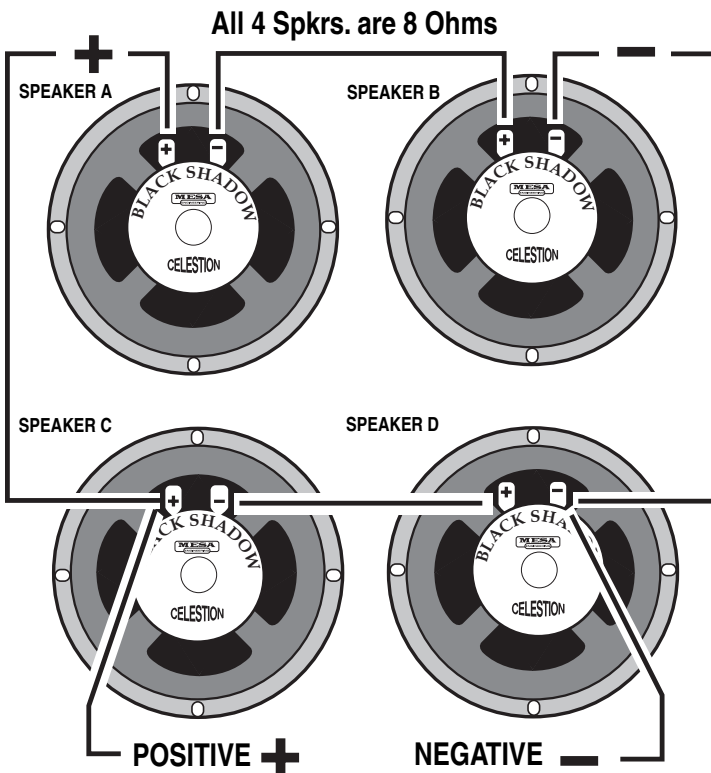

Simply connect the Positive side of Speaker A to the Positive side of Speaker C.

Connect the Negative side of Speaker A to the Positive side of Speaker B. Next, connect the Negative side of Speaker C to the Positive side of Speaker D.

And lastly, connect the Negative side of Speaker B to the Negative side of Speaker D.

4 Eight (8) Ohm speakers wired in Series Parallel = a Total Load of 8 Ohms.

WIRING SCHEMES...Amplifier to Speaker Cabinets

1

2

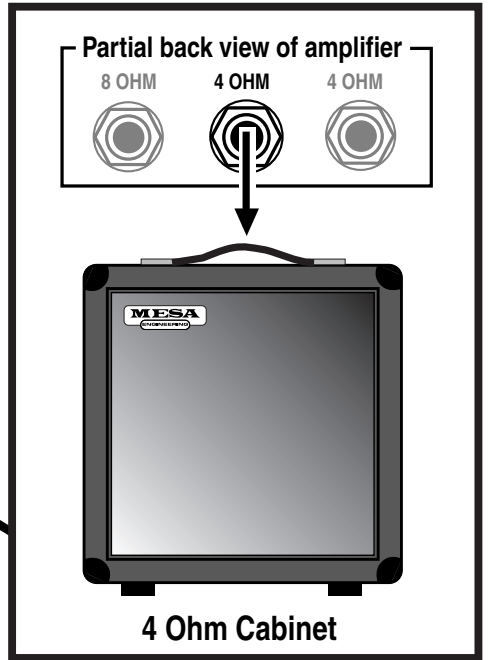
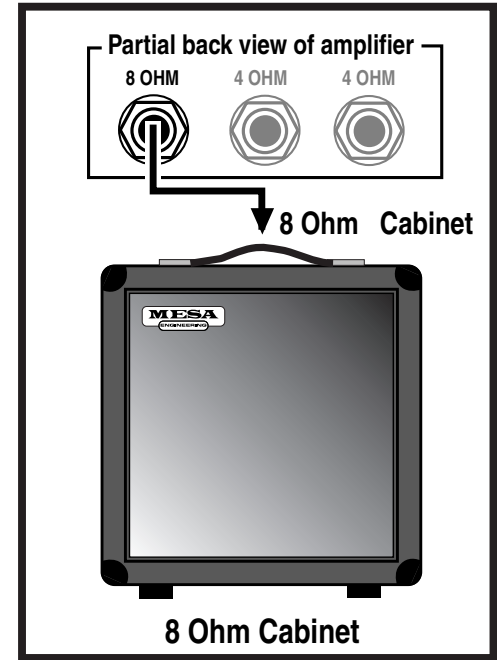

3

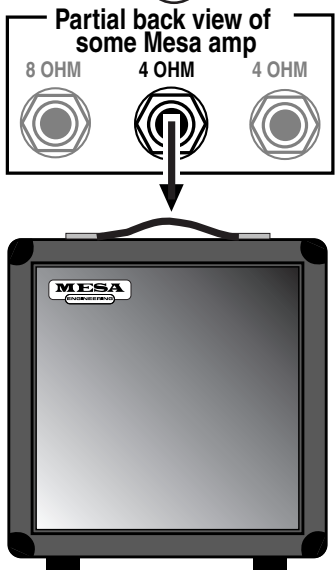

4

5

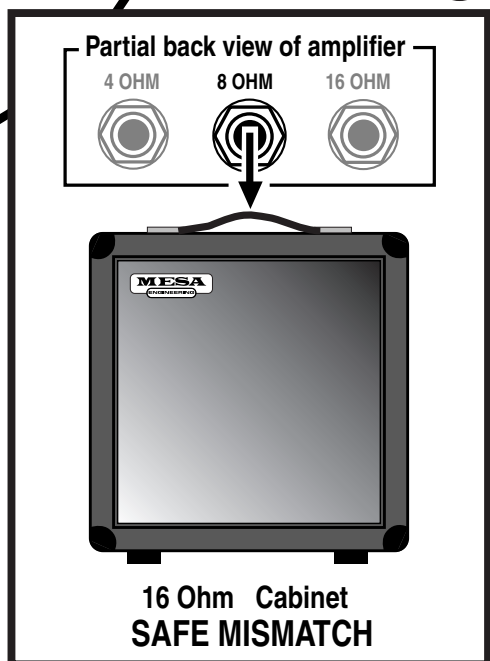
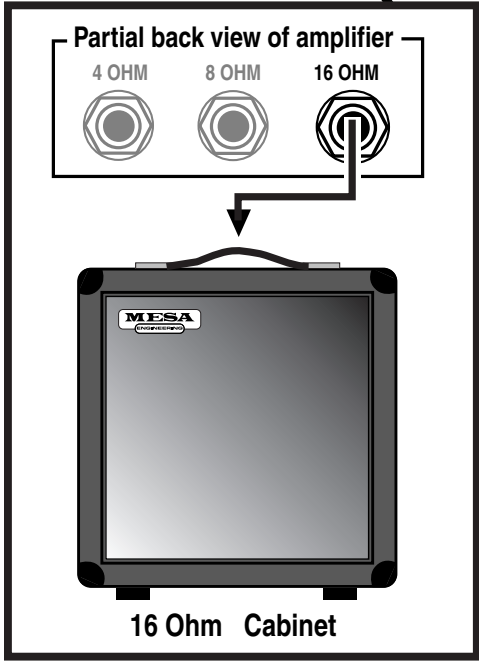

WIRING SCHEMES...Amplifier to Speaker Cabinets

6

7

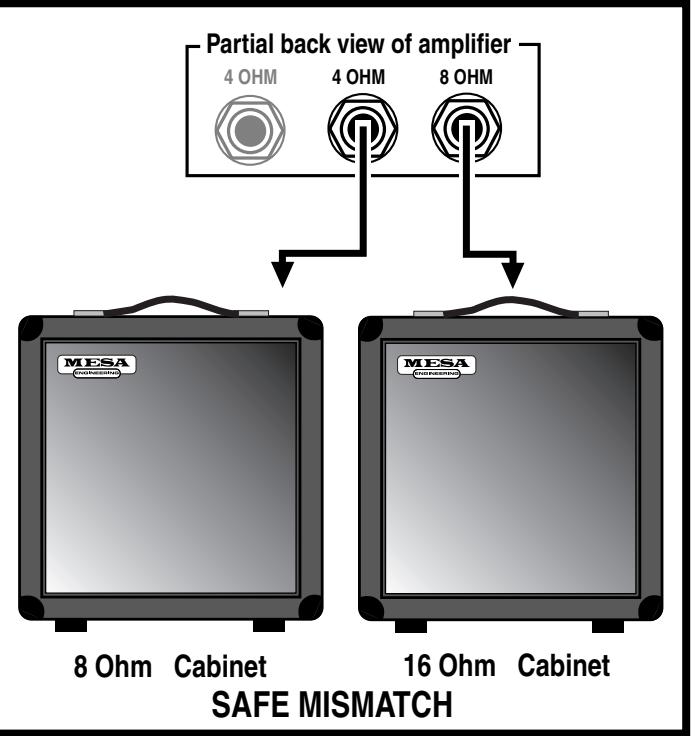
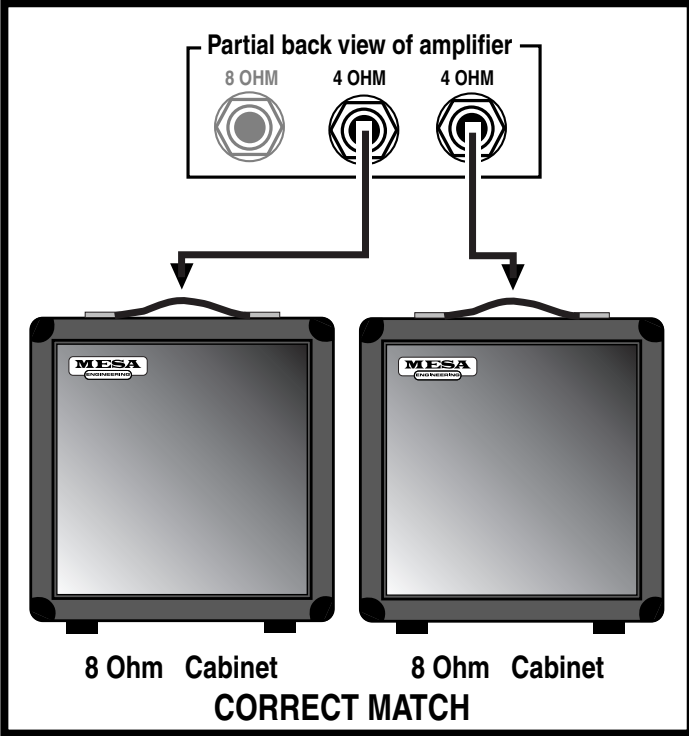

8

9

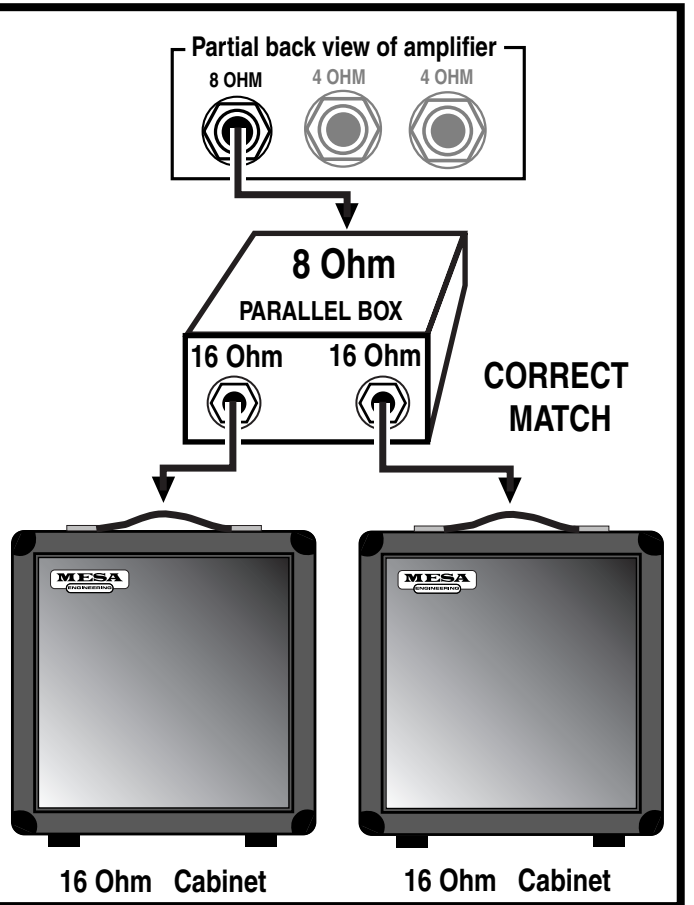
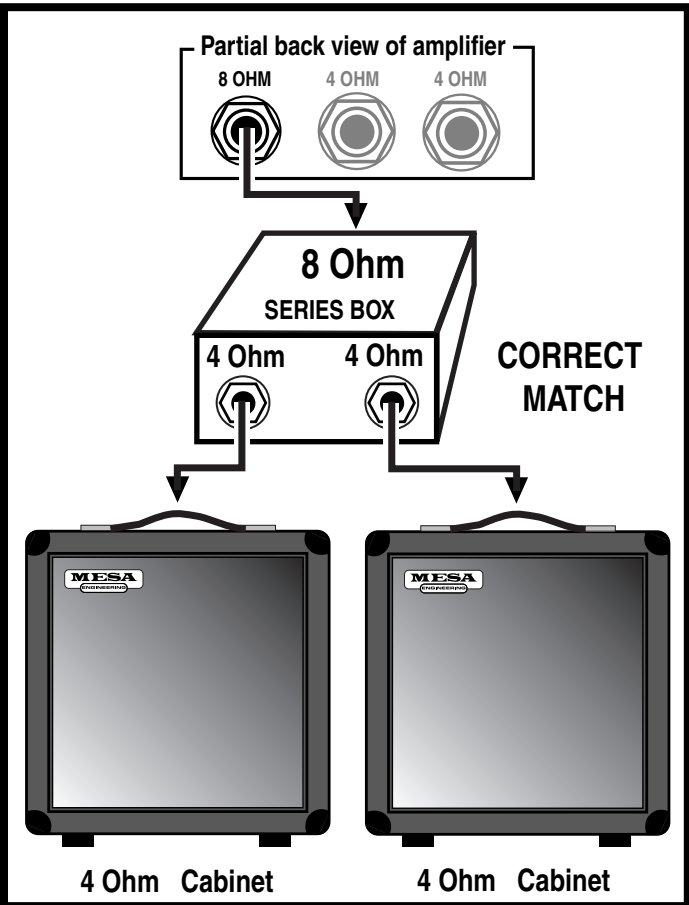

WIRING SCHEMES...Amplifier to Speaker Cabinets

10

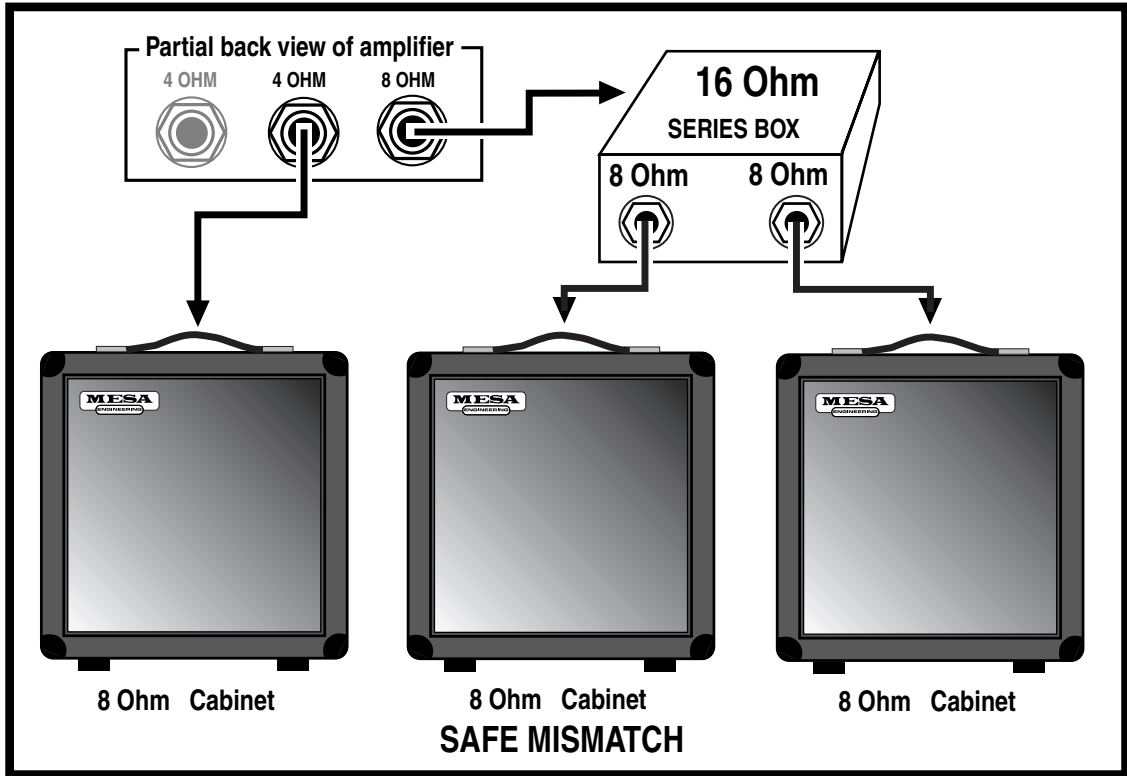

11

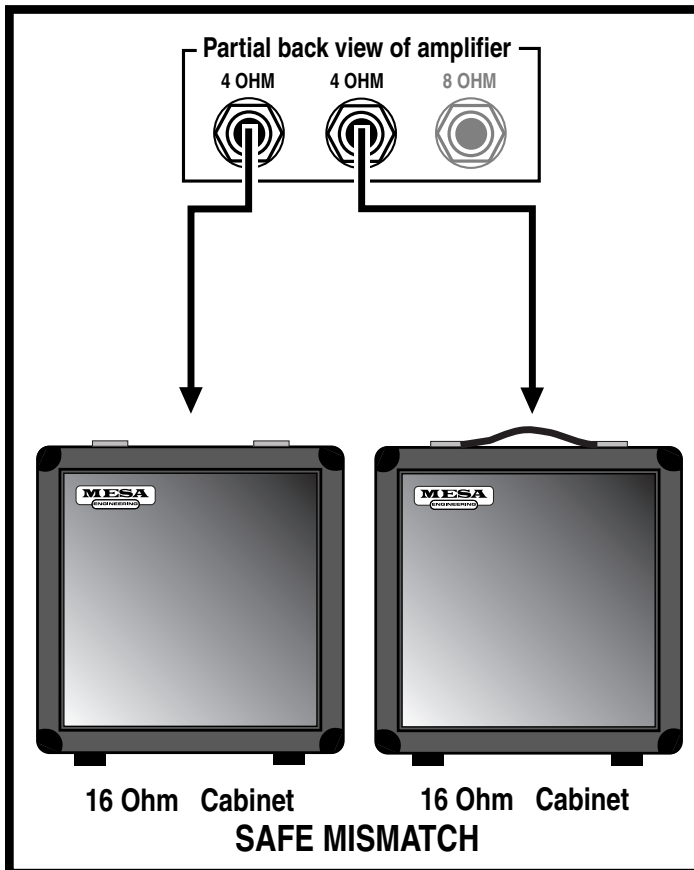

12

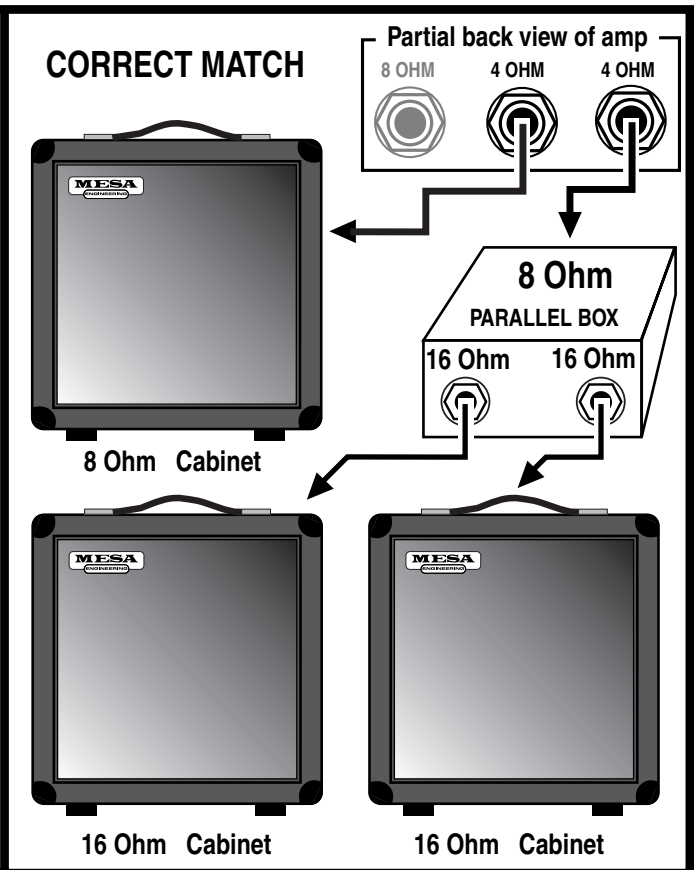

WIRING SCHEMES...Amplifier to Speaker Cabinets

13

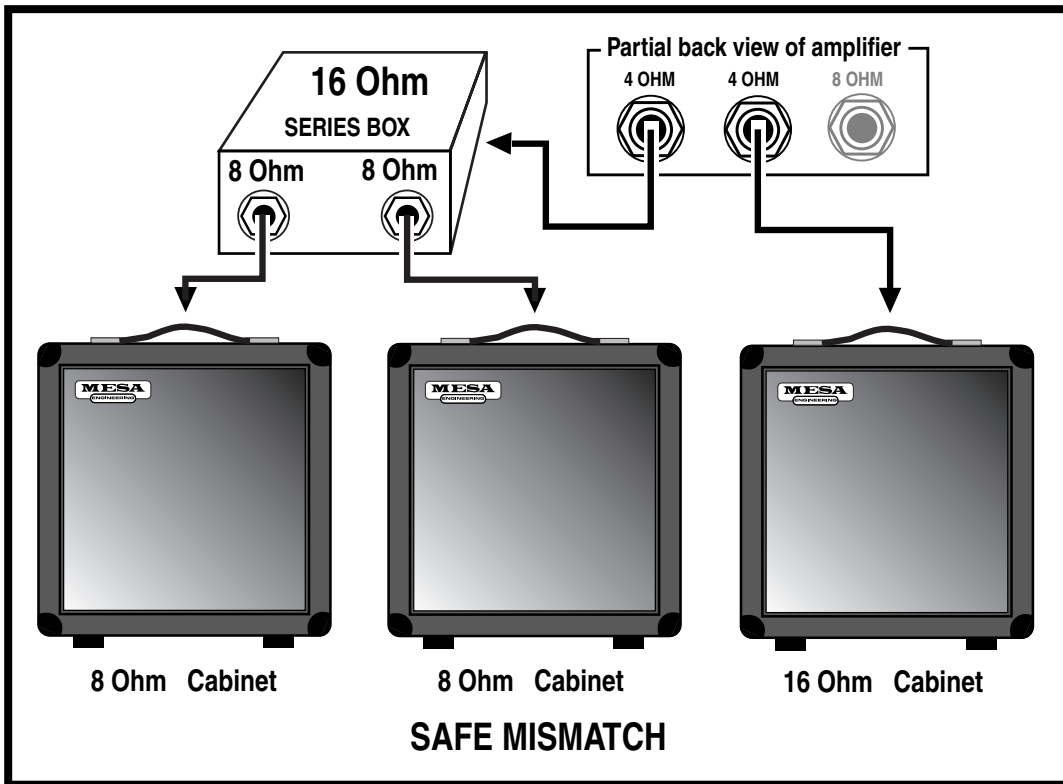

14

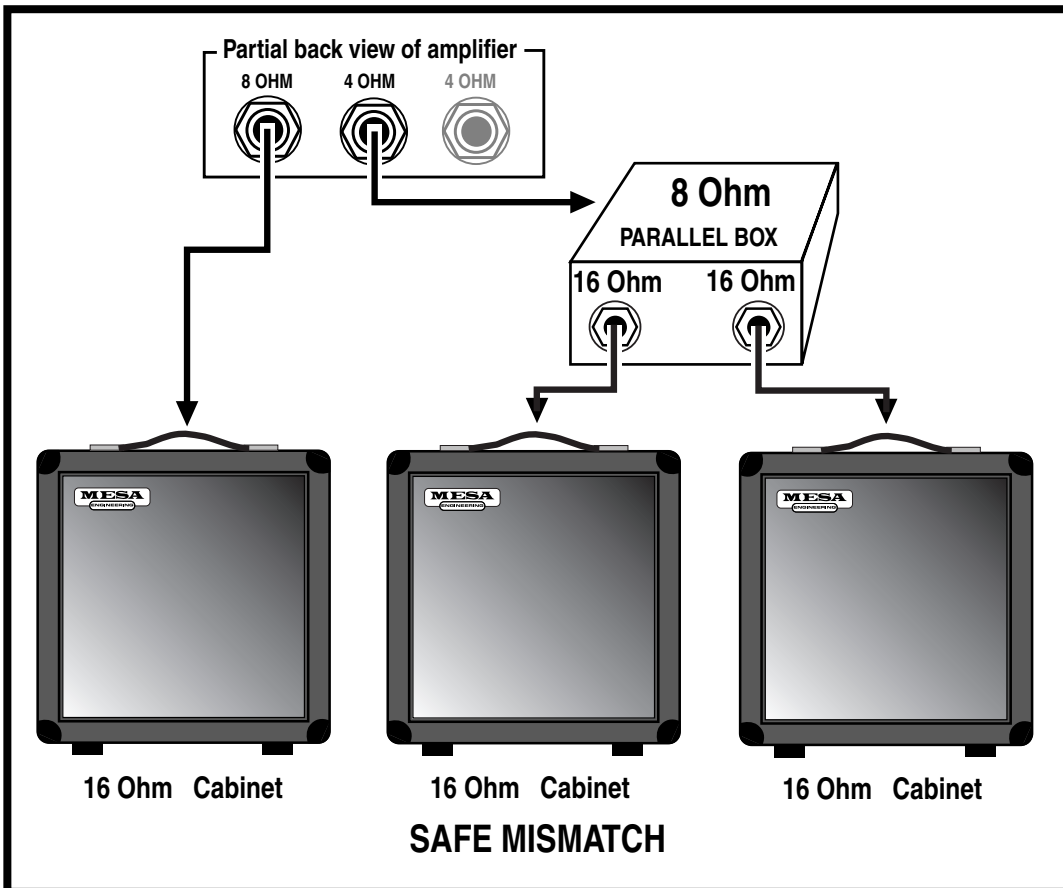

With apologies to Friends and Relatives from the Emerald Isle - who will make their appearance soon enough - the humor which follows is dedicated to the memories of Spec McAuliff and Fae (Rafael) McNally, two of the True Greats.

As their numerical references suggest, the terms Diode, Triode and Pentode indicate the number of elements within the vacuum tube i.e. two, three or five. All tubes also require a filament or heater which is not included in the count. Its purpose is to excite electrons from the cathode coating by raising the temperature such that they are able to boil out of the electron-rich coating material and form a cloud of free electrons in the vacuum space surrounding the cathode.

Although the term filament and heater are often used interchangeably, there are specific differences: A filament is a directly heated cathode where cathode coating is applied directly to the heating element. Examples are 5U4 twin diode rectifier and 300B triode amplifier tubes. A heater, on the other hand, is a heating element which is separate from the cathode and is usually inserted within the tubular cathode sleeve. Examples are 12AX7 twin triode amplifier and 6V6 or EL84 beam power pentode tubes. In all cases this fundamental aspect of each tube's construction is clearly visible, especially when the heating element is glowing red hot.

The cathode, then, would be considered the first numbered element because it is the source of the electrons. The word itself is from the Greek literally meaning completely down, which implies a sense of central origin - like the center of the earth where Tone begins. It might be said that an ecstatic audiophile experiences a positive catharsis, his soul being purified when his system transports him to Audio Nirvana. The only trouble with taking this positive imagery too far is that the cathode is, unfortunately, negative... at least electrically speaking. However this is easily remembered since virtually all musicians and audiophiles have also experienced the more common negative catharsis when they emerge from the emotional rebirth kicking and screaming in rage and frustration.

Once heated, the intrinsically negative electrons are energetic little fellows of almost no mass. Thus they may be accelerated almost instantaneously and will travel through a vacuum a nearly the speed of light. Being of like, negative charge, they tend to repel one another and thus within the electron cloud surrounding the cathode, there is much jostling and elbowing as each one tries to maintain his distance from all the others... unless there is a strong and universal attraction from an outside influence.

Visualize, if you will, a group of sub-atomic Irishmen milling about and in a repellent, negative state of mind. All are scowling and none wants to have anything to do with the other. Now introduce a strong attraction say, a public bar, and you can easily picture an orderly, if rapid movement of the lot in a single direction. This is what happens when a positively charged element called the anode or plate is introduced into the vacuum.

The plate is the large metal element most prominently visible through the glass of an electron tube. It is the outermost element of a tube's structure and it surrounds all the others. The cathode is at the center radiating electrons outwards. As higher and higher positive voltage is applied to the plate, the attraction for the electrons surrounding the cathode is increased and with nothing standing in the way, full uninhibited flow to the plate occurs... sort of like removing the doors and offering free drinks to the crowd of surly Irishmen milling around outside. As electrons flow to the plate, the space charge will continually be replenished by further 'boiling' of the hot, electron-rich cathode as you can easily imagine other Irishmen impatiently taking up the places of those who've gone inside - until the entire village is deserted.

Now, where do they come from and how do they emerge? Well, a grand and elegant lady once showed me how to revive flat champagne: She dropped a raisin into the glass. There was a dramatic and immediate increase in effervescence with the introduction of a cathoding surface. Thousands of tiny bubbles suddenly appeared - and continued to flow from the raisin. Of course the bubbles were made up of gas dissolved in the beverage, but the analogy makes it easy to visualize the loosely bound electrons dissolved in the rich cathode coating as they effervesce from its heated surface.

But back to the electron flow. If the electrons are strongly attracted to a positively charged plate, then it follows that they are strongly repelled by a negatively charged plate and they are. Thus, if an alternating current - such as comes from a transformer - is applied to the plate, electrons will flow only during the times when the plate is positively charged. During periods of negative plate charge, electron flow is stopped and the space charge of electrons remains compressed in the area around the cathode.

ON TRIODES, PENTODES & IRISHMEN: (Continued)

Thus a diode tube - one with a cathode and an anode - is mostly used to rectify alternating current into direct current by passing it without restriction, but in one direction only. This also explains why closing time is strictly enforced at Irish pubs: During normal operation, the traffic flow is similarly unimpeded and uni-directional toward the bar and this process rectifies the work-day negativity. It goes without saying that no one leaves as long as the atmosphere around the bar remains positively charged.

TRIODES:

This section is a continuing technical treatise on the workings of Irish Pubs but to make it easier for the layman to understand, it is explained in terms of vacuum tube technology. Enter the original bar - free beer and no doors. Well, it turns out that some control over the flow can be a necessary and useful advantage. This led to the invention of those swinging louvered saloon doors which are open at the top and bottom. They are patterned after the control grid of the vacuum tube, which is a loosely wound coil of thin wire located between the cathode and the plate.

In a Triode the plate is always positively charged with high voltage D.C. and even though the grid is blocking the path, those negative electrons can still FEEL the strong attraction - just as the Irishmen can see in through the louvers of the bar doors. They know what pleasures lie beyond, but to get there requires overcoming the negative influences controlling the access. This negative influence is typically called a Bias. In electronic terms that means the grid is supplied with a voltage which is slightly MORE NEGATIVE than the already negative electrons. The more negative the Bias, the more it tends to neutralize the attraction of the plate and repel the electrons back toward the cathode.

The Irish can be similarly charged with Bias, but unless you are Irish yourself, this type of Biasing may be more difficult to understand. The effect is similar though: The more negative the Bias, the more it impedes forward progress. Generally speaking though, the electronic Bias of the grid is easiest to overcome, and for two main reasons: First, the Bias is set - like the bar doors - to allow some passage. Second, the grid is mostly NOT THERE, like the louvered doors which are mostly open spaces. Unlike the plate which is solid, the grid is like a coiled bed spring. It can create a repelling field but mostly it's empty space in between widely separated windings of wire. It's very easy to control the electrons as they pass through the grid's force field: Changing the grid voltage only slightly will have an enormous effect on how much current flows through... and that's what AMPLIFICATION is: a small change in voltage at the grid causing a large change in current flowing to the plate.

The purpose of the louvered bar doors is similar to that of the grid, namely, to give momentary pause while still revealing the promise within. Hesitation mostly gives way to temptation, but there are those few stalwart Irishmen who think twice and decide to come back later. Most just pause slightly then go on through. That is the purpose of the bar doors: to prevent everyone from crowding in all at once - and as the door is made less of a barrier, wider spaces between the louvers, more of the bar's attractive influence is felt outside thus amplifying the customer flow and increasing the crowd at the bar.

PENTODES:

Occasionally though, bar doors - even the louvered type - were found to be too effective, and too many customers turned away. Something further was needed to increase the attraction of the bar and overcome the resistance created by the door. Thus the cocktail waitress was invented.

Once again the idea was inspired by the vacuum tube. It had been discovered in some tubes, often large power types, that the distance to the plate was too great to attract enough electrons past the negative influence of the control grid. So another grid coil of fine wire was inserted between the first grid and the plate. This was called the screen grid and carrying a highly positive charge, it functioned as a "bait" for the plate.

In a properly designed power tube such as an EL84 or a 6V6, the windings of the screen grid are precisely aligned to fall in the shadow of the control grid. This way the electrons responding to the pull of the screen grid are lined up in sheets as they pass between windings of the inner control grid... only to find that they have been fooled! Once past the control grid and drawn toward the screen grid, they discover...there's almost nothing there. The path they're on has them aligned to zing straight through the spaces BETWEEN screen grid windings. So rather than a close and personal encounter, they just fly on past - and once they're out that far, there's no stopping them. The influence of the plate takes over and - being solid metal and of the highest positive attraction - it is at this final destination that the electrons congregate.

PENTODES: *(Continued)* Thus the proper cocktail waitress - visible through the louvers - is scantily clad so as to be all the more effective at reinforcing the attractive influence of her bar and by being located in between the door and the bar, she serves as bait to lure customers past the door's negative influence. Once through the door however, it is the rare Irishman who actually comes in personal contact with the cocktail waitress as, for all intents and purposes, she - like the screen grid - turns out to be a vanishing illusion. Yet, having come this far, the solid influence of the bar itself now takes over and attracts the customers to congregate, having happily reached their destination.

If you're still following this and haven't lost track of the count, you'll know we're still one element short of the five needed to make a Pentode. This last part is a pair of beam-confining shields which being negatively charged, serve to direct the flow right toward the plate. This is much the way a short entrance hall to the bar prevents wandering accidentally into the Men's room on the way.

Once at the bar though, the circuit is complete and the process of soul-nourishing works its ritual magic. Biases having been overcome, illusory nightingales having vanished, the spirits truly soar and the once surly Irishmen now are filled with warmth, wit and kindred friendship, enjoying the music and glowing nicely with their heaters on.

With appreciative thanks to the inhabitants of the Land of the Leprechaun, we have now concluded our little diversion into the mechanics of proper bar lay-out.

A feature article by Randall Smith
Designer / President

Mark V

BEFORE CHANGING TUBES FLIP POWER SWITCH TO OFF

Tube Replacement

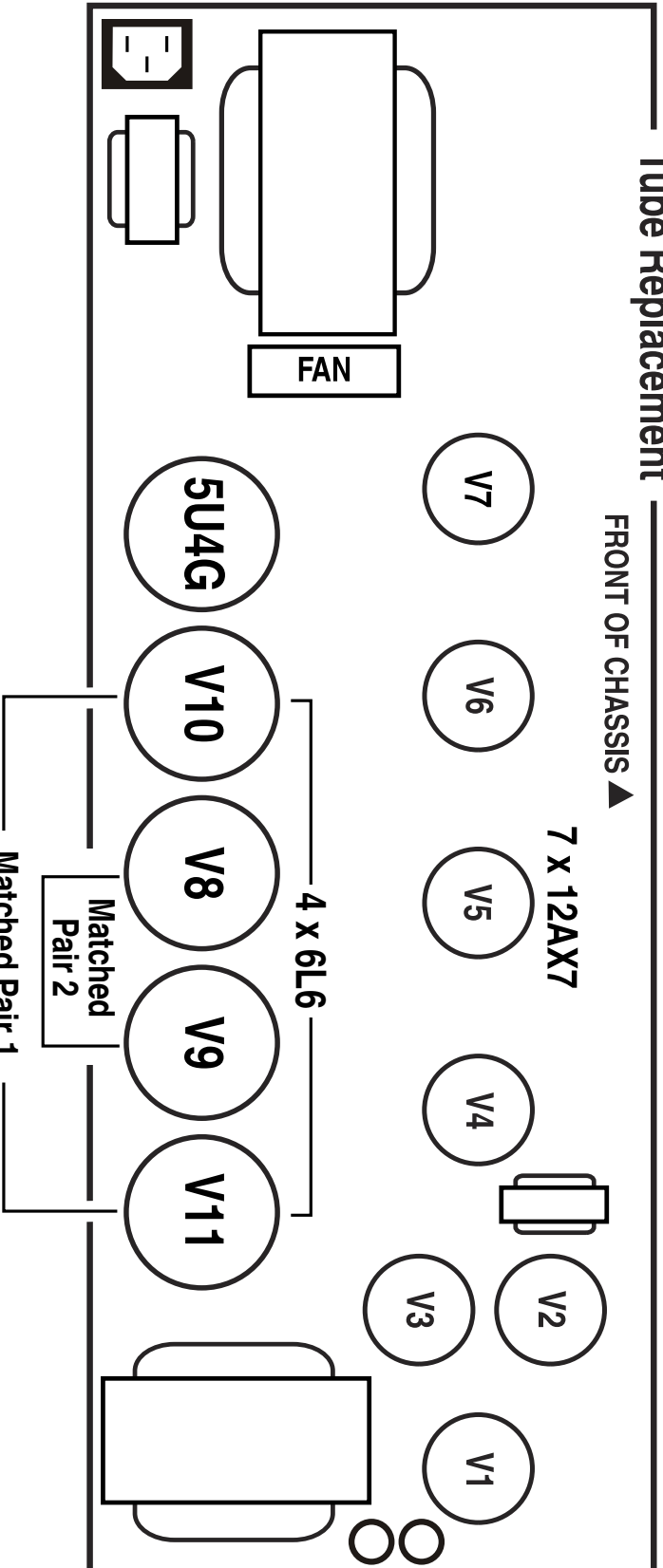

Preamp Tubes	
V1A-- Input Stage	V4A-- Reverb Send
V1B-- 2nd Gain stage CH1/CH3, 3rd Gain Stage CH2	V4B-- 2nd Drive stage CH3
V2A-- 2nd Gain Stage CH2	V5A-- 1st Drive stage CH3
V2B-- n/a	V5B-- Reverb return
V3A-- 3rd Gain Stage CH1/CH3, 4th Gain Stage CH2	V6A-- 4th Gain stage CH3
V3B-- 4th Gain Stage CH1	V6B-- Effects return stage
	V7A&B-- Driver/Phase inverter

Power Tubes
90 Watts = V8, V9, V10, V11
45 Watts = V8, V9
10 Watts = V8, V10

NOTES

MESA/BOOGIE

The Spirit of Art in Technology

Thank you for trusting MESA/Boogie to be your amplifier company and we wish you many years of toneful enjoyment from this handbuilt all tube instrument.



The Spirit of Art in Technology



(707) 778-6565 FAX NO. (707) 765-1503
1317 Ross Street Petaluma, CA 94954
USA

03/03/10